



Bringing Light
to Life

PRICE LIST
W.E.F. 1st JULY 2022

**We are a lighting solutions company.
While at the same time, we are more than that.**

Like everything in nature is constantly evolving, we as a Lights manufacturing company too are evolving incessantly.

With over a decade of experience alongside the extremely creative and dynamic teams both internally and externally, we have now developed a clear understanding of what it means to provide lighting solutions.

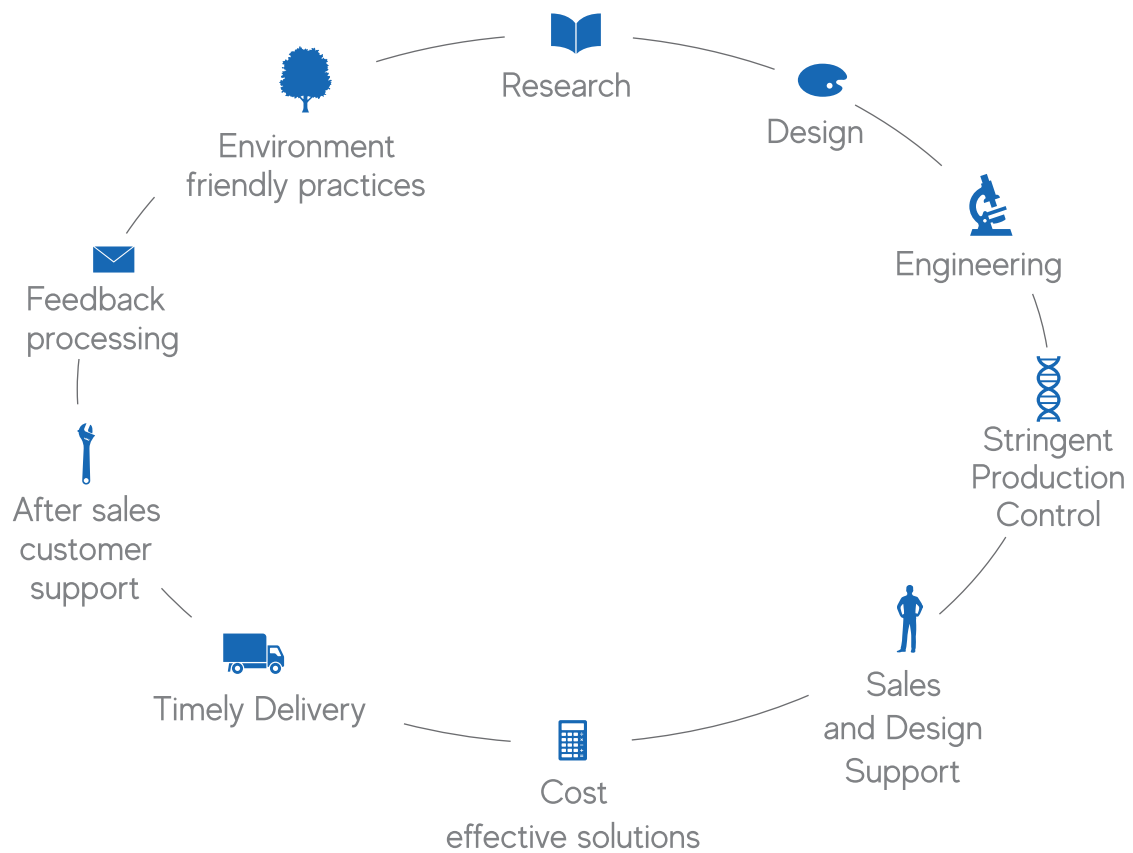

Our focus is to provide a large range of standard and custom-made solutions to meet the need of distinctive projects.

If it has been designed or even imagined, we aim to create the solutions and ensure it has served the space in the best way possible.

Simply put, we are just not a catalogue of products, we are your extended team striving to achieve perfection in every project.

Made In India

R&D Setup

Our Research & Development laboratory comprises various types of testing equipment. These help us keep up with the latest industry standards in the field of lighting. Our lab also caters to harnessing newer technologies in manufacturing, thus helping us achieve maximum efficiency, top-notch quality to leave a minimal carbon footprint.

Testing Equipments

- Power Analyzers
- Humidity chamber
- Thermal imager
- LCR meter
- Goniophotometer
- Integrated Sphere
- Digital Oscilloscope
- Reliability Safety Tests Equipments

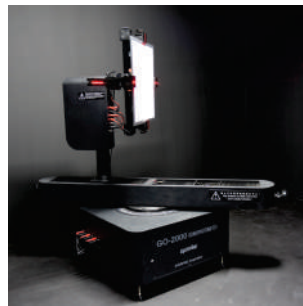

Manufacturing Setup

Our team comprises of skilled employees with strong product validation and QC standard's experience & knowledge to produce quality products. With updated machinery and equipments, it has eased achieving manufacturing efficiency. We are capable of executing supplies of projects of any scale with current available bandwidth and setup.

- 25000 sq. ft. of built up manufacturing facility
- Line and Ageing test to improve product performance
- Updated machinery
- In-house driver design & development setup
- SMT machine for in house LED mounting
- Tool designing Team for OEM working

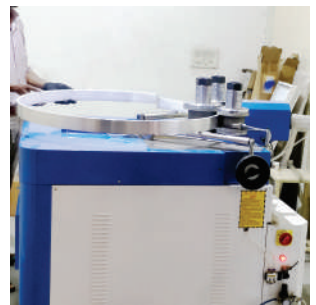

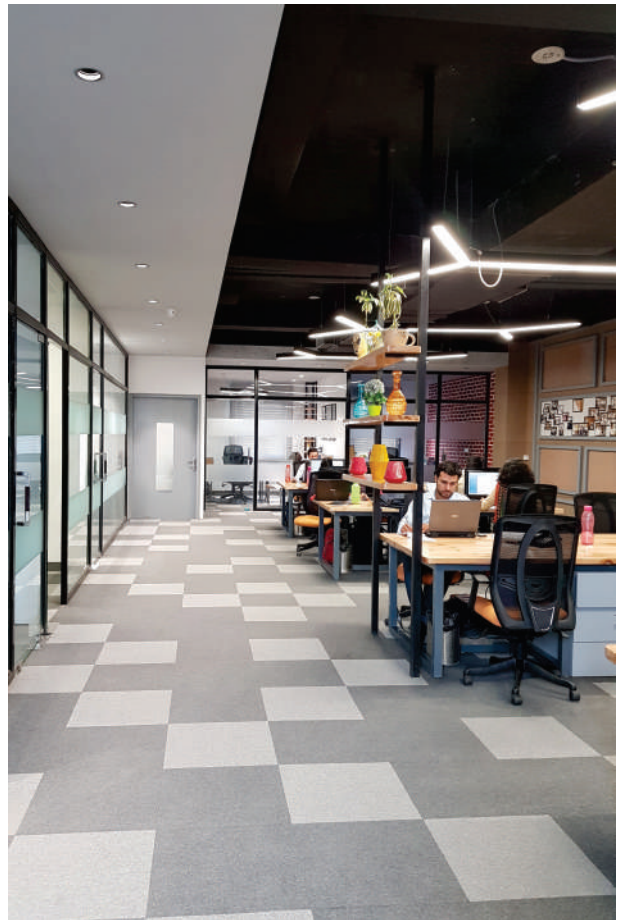

Brighten up spaces

Our solutions have lit up offices, industrial and commercial spaces, outdoors and consumer areas. We are constantly looking at ways to improve the end users' quality of life, and not just meet, but exceed our customers' expectations.

Our products:

Prismatic Range	—————	7-10
Recessed Downlights	—————	11-18
Surface & Suspended Downlight	—————	19-23
Consumer Luminaires	—————	24-25
Recessed Luminaires	—————	28-29
Surface & Suspended Luminaires	—————	30
Architectural Luminaires	—————	31-36
Industrial & Outdoor Luminaires	—————	39-50
Decorative Luminaires	—————	52

Legero Prismatic Range

Ribbon Prism



This contemporary aerial luminaire is a masterpiece that will add a swanky ambiance to your space. The LED fixture features excellent glare-free light distribution with prismatic diffuser and lightweight extruded aluminium housing for an easy installation. Its sleek design and functionality blend in an incredibly eye-catching ribbon-like shape, making a dapper statement while saving you up to 80% on energy costs.

Product ID	Watt	CCT	Dimension (mm) l b h
LSR 1020P	20	3000K/4000K/6000K	1000 70 60
LSR 1030P	30	3000K/4000K/6000K	1000 70 60

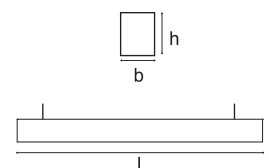

Available Colors

Techpro Prism Direct



IP20

Backlit linear light, housing made in Extruded Aluminium with high efficiency prismatic diffuser to reduce the product glare rating. UGR : < 19. Suitable for Armstrong Techzone ceiling.

Product ID	Watt	CCT	Dimension (mm) l b h	MRP
LTL 1030PR	30	3000K/4000K/6000K	1195 145 65	

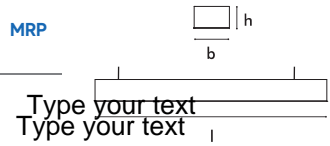

Available Colors

Techpro Prism Up & Down



IP20

Backlit linear light, housing made in Extruded Aluminium with high efficiency prismatic diffuser to reduce the product glare rating. UGR : < 19. Suitable for Armstrong Techzone ceiling. Upward/Downward ratio - 20:80.

Product ID	Watt	CCT	Dimension (mm) l b h	MRP
LTL 2035PR	35	3000K/4000K/6000K	1195 145 65	

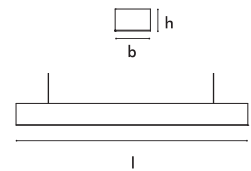

Available Colors

Strapline Prism 50 Up & Down



IP20

Direct - Indirect Linear light with Extruded Aluminium body and snapfit high efficiency prismatic diffuser to reduce the glare. UGR : < 19. Suitable for high productive office application. Upward/Downward ratio - 20:80.

Product ID	Watt	CCT	Dimension (mm) l b h	MRP
LSL-S 5130PR	30	3000K/4000K/6000K	1000/1200 52.8 101	
LSL-S 5140PR	40	3000K/4000K/6000K	1000/1200 52.8 101	

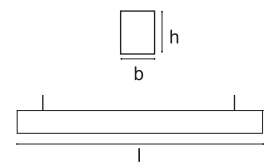

Available Colors

Strapline Prism 50 Suspended



IP20

Linear light with Extruded Aluminium body and snapfit high efficiency prismatic diffuser to reduce the glare. UGR : < 19. Suitable for high productive office application.

Product ID	Watt	CCT	Dimension (mm) l b h	MRP
LSL-S 5020PR	20	3000K/4000K/6000K	1000/1200 63 80	
LSL-S 5030PR	30	3000K/4000K/6000K	1000/1200 63 80	

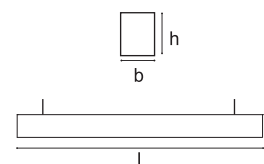

Available Colors

Strapline Prism 50 Recessed



IP20

Linear light with Extruded Aluminium body and snapfit high efficiency prismatic diffuser to reduce the glare. UGR : < 19. Suitable for high productive office application.

Product ID	Watt	CCT	Cutout (mm) l x b	Dimension (mm) l b h	MRP
LSL-R5020PR20	3000K/4000K/6000K	992/1192	55 1000/1200 63 80		
LSL-R5030PR30	3000K/4000K/6000K	992/1192	55 1000/1200 63 80		

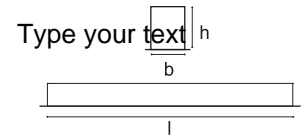

Available Colors

Pill Prism Suspended



IP20

Round extruded aluminium housing with Prismatic diffuser. High efficient LEDs for uniform light distribution with UGR : < 19.

Product ID	Watt	CCT	Dimension (mm) ø h	MRP
ALP-S 4130PR	30	3000K/4000K/6000K	400 60	
ALP-S 5145PR	45	3000K/4000K/6000K	500 60	
ALP-S 6156PR	56	3000K/4000K/6000K	600 60	
ALP-S 9180PR	80	3000K/4000K/6000K	900 60	
ALP-S 12100PR	100	3000K/4000K/6000K	1170 60	

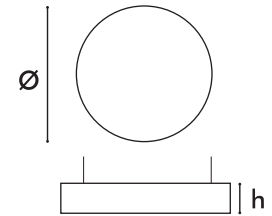

Available Colors

Ripple Prism

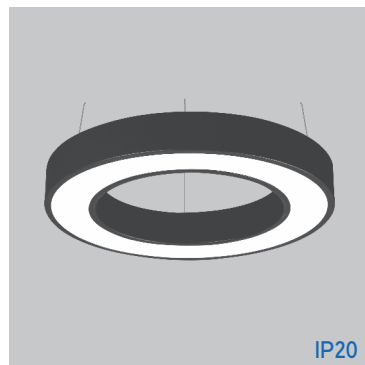

IP20

Round extruded aluminium housing with diffuser. Smart circular ring gives functional decorative look. Also diffuser is so fixed to provide uniform light output.

Product ID	Watt	CCT	Dimension (mm) ø h	MRP
ARL 6030PR	30	3000K/4000K/6000K	600 60	
ARL 9055PR	55	3000K/4000K/6000K	900 60	
ARL 12080PR	80	3000K/4000K/6000K	1170 60	
ARL 15000PR		3000K/4000K/6000K	1500 60	
ARL 18000PR	As per Request	3000K/4000K/6000K	1800 60	
ARL 20000PR		3000K/4000K/6000K	2000 60	
ARL 24000PR		3000K/4000K/6000K	2400 60	

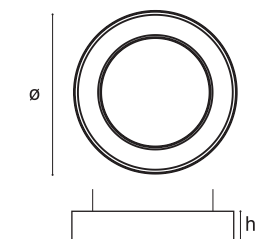

Available Colors

Modena Prism



IP20

Recessed Grid Ceiling Luminaire with high efficiency prismatic diffuser to reduce the product glare rating. Suitable for high productive office application. UGR : < 19

Product ID	Watt	CCT	Cutout (mm) l x b	Dimension (mm) l b h	MRP
LER 2628PR	28	3000K/4000K/6000K	575 x 575	595 595 76	
LER 2636PR	36	3000K/4000K/6000K	575 x 575	595 595 76	
LER 2640PR	40	3000K/4000K/6000K	575 x 575	595 595 76	

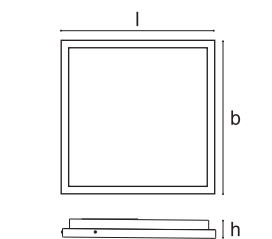

Available Colors

Modena Prism 1x4



1X4 Recessed Grid Ceiling Luminaire with high efficiency prismatic diffuser to reduce the product glare rating. Suitable for high productive office application. UGR : < 19

Product ID	Watt	CCT	Cutout (mm) l x b	Dimension (mm) l b h	MRP
LER 1240PR	40	3000K/4000K/6000K	1175 x 275	1195 295 80	

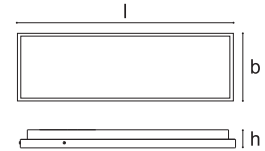

Available Colors

Atmos Prism



Sleek round backlit LED downlight made up of die-cast housing & light weight plastic trim which is designed as a reflector to give high lumen efficacy. Also Prismatic diffuser is fixed in inner periphery of trim to cut down the glare & provide uniform light output.

Product ID	Watt	CCT	Cutout (mm) ø	Dimension (mm) ø h	MRP
LAT 009PR	9	3000K/4000K/6000K	110	126 40	
LAT 013PR	13	3000K/4000K/6000K	110	126 40	
LAT 016PR	16	3000K/4000K/6000K	140	160 40	
LAT 018PR	18	3000K/4000K/6000K	140	160 40	

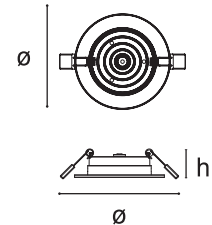

Available Colors

Pearl Prism (R)



Sleek round backlit LED downlight made up of die-cast housing & light weight plastic trim designed for better aesthetics with high efficacy LEDs and prismatic diffuser to give glare free output.

Product ID	Watt	CCT	Cutout (mm) ø	Dimension (mm) ø h	MRP
LRS 2005PR	5	3000K/4000K/6000K	79	108 30	
LRS 2012PR	12	3000K/4000K/6000K	105	130 30	
LRS 2015PR	15	3000K/4000K/6000K	138	160 30	
LRS 2018PR	18	3000K/4000K/6000K	138	160 30	

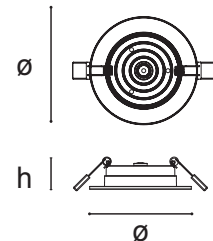

Available Colors

Pearl Prism (Sq)



Sleek square backlit LED downlight made up of die-cast aluminium housing & light weight plastic trim designed for better aesthetics with high efficacy LEDs and Prismatic diffuser to give glare free output.

Product ID	Watt	CCT	Cutout (mm) l x b	Dimension (mm) l b h	MRP
LRS 3005PR	5	3000K/4000K/6000K	79 x 79	108 108 30	
LRS 3012PR	12	3000K/4000K/6000K	105 x 105	130 130 30	
LRS 3015PR	15	3000K/4000K/6000K	138 x 138	160 160 30	
LRS 3018PR	18	3000K/4000K/6000K	138 x 138	160 160 30	

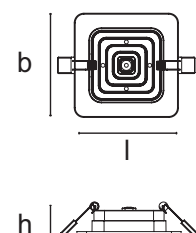

Available Colors

Recessed Downlights

Omega



IP20

A versatile collection of energy efficient round LED downlight for general lighting in various applications. These recessed diffused round LED downlights are made of high efficient die-cast aluminium housing with high transmission factor diffuser.

Product ID	Watt	CCT	Cutout (mm) \varnothing	Dimension (mm) \varnothing h	MRP
LVT 6507	7	3000K/4000K/6000K	102	112 53	
LVT 6509	9	3000K/4000K/6000K	134	145 53	
LVT 6512	12	3000K/4000K/6000K	134	145 53	
LVT 6515	15	3000K/4000K/6000K	164	175 60	
LVT 6518	18	3000K/4000K/6000K	164	175 60	
LVT 6522	22	3000K/4000K/6000K	164	175 60	

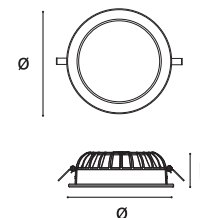
Available Colors 

Omega-D



IP20

Compact styling, clean fascias and enclosed precision die-cast adjustable lamp housing with polycarbonate diffuser & energy efficient light sources .

Product ID	Watt	CCT	Cutout (mm) \varnothing	Dimension (mm) \varnothing h	MRP
LHR 6920	20	3000K/4000K/6000K	133	145 88	
LHR 6925	25	3000K/4000K/6000K	133	145 88	
LHR 6930	30	3000K/4000K/6000K	133	145 88	

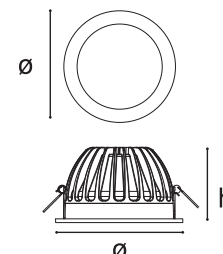
Available Colors 

Oculus



IP20

Sleek round backlit LED downlight made up of die-cast housing with ring shape diffuser to give decorative & unique look to the product.

Product ID	Watt	CCT	Cutout (mm) \varnothing	Dimension (mm) \varnothing h	MRP
LOC 015	15	3000K/4000K/6000K	129	135 36	
LOC 018	18	3000K/4000K/6000K	129	135 36	
LOC 020	20	3000K/4000K/6000K	129	135 36	

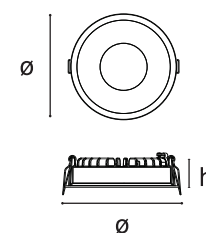
Available Colors 

Atmos



IP20

Sleek round backlit LED downlight made up of die-cast housing & light weight plastic trim which is designed as a reflector to give high lumen efficacy. Also opal diffuser is fixed in inner periphery of trim to cut down the glare & provide uniform light output.

Product ID	Watt	CCT	Cutout (mm) \varnothing	Dimension (mm) \varnothing h	MRP
LAT 009	9	3000K/4000K/6000K	110	126 40	
LAT 013	13	3000K/4000K/6000K	110	126 40	
LAT 016	16	3000K/4000K/6000K	140	160 40	
LAT 018	18	3000K/4000K/6000K	140	160 40	

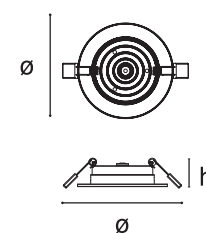
Available Colors 

Pearl (R)



Sleek round backlit LED downlight made up of die-cast housing & light weight plastic trim designed for better aesthetics with high efficacy LEDs and diffuser to give glare free output.

Product ID	Watt	CCT	Cutout (mm) \varnothing	Dimension (mm) \varnothing h	MRP
LRS 2005	5	3000K/4000K/6000K	79	108 30	
LRS 2012	12	3000K/4000K/6000K	105	130 30	
LRS 2015	15	3000K/4000K/6000K	138	160 30	
LRS 2018	18	3000K/4000K/6000K	138	160 30	

Available Colors

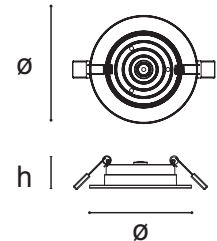

Pearl (Sq)



Sleek square backlit LED downlight made up of die-cast aluminium housing & light weight plastic trim designed for better aesthetics with high efficacy LEDs and diffuser to give glare free output.

Product ID	Watt	CCT	Cutout (mm) l x b	Dimension (mm) l b h	MRP
LRS 3005	5	3000K/4000K/6000K	79 x 79	108 108 30	
LRS 3012	12	3000K/4000K/6000K	105 x 105	130 130 30	
LRS 3015	15	3000K/4000K/6000K	138 x 138	160 160 30	
LRS 3018	18	3000K/4000K/6000K	138 x 138	160 160 30	

Available Colors

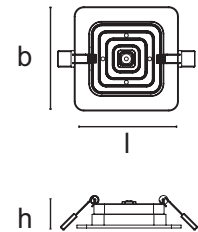

Coral (R)



Sleek round panel downlight with integrated edge-lit LEDs installed with highly efficient low glare diffuser for optimum light distribution. Housing is made of pressure die-cast aluminium.

Product ID	Watt	CCT	Cutout (mm) \varnothing	Dimension (mm) \varnothing h	MRP
LRS 4006	6	3000K/4000K/6000K	80	95 30	
LRS 4012	12	3000K/4000K/6000K	142	159 30	
LRS 4015	15	3000K/4000K/6000K	142	159 30	
LRS 4018	18	3000K/4000K/6000K	176	196 30	
LRS 4022	22	3000K/4000K/6000K	176	196 30	

Available Colors

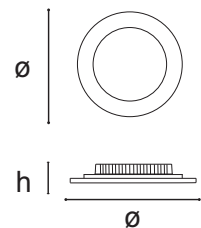

Coral (Sq)



Sleek square panel downlight with integrated edge-lit LEDs installed with highly efficient low glare diffuser for optimum light distribution. Housing is made of pressure die-cast aluminium.

Product ID	Watt	CCT	Cutout (mm) l x b	Dimension (mm) l b h	MRP
LRS 5006	6	3000K/4000K/6000K	83.5 x 83.5	100 100 30	
LRS 5012	12	3000K/4000K/6000K	119.5 x 119.5	140 140 30	
LRS 5015	15	3000K/4000K/6000K	119.5 x 119.5	140 140 30	
LRS 5018	18	3000K/4000K/6000K	176 x 176	190 190 30	
LRS 5022	22	3000K/4000K/6000K	176 x 176	190 190 30	

Available Colors

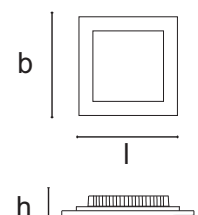

Mist (R)



Compact & sleek round LED backlit downlight made up of polycarbonate housing, high efficacy LEDs, high grade material diffuser to give uniform & glare free output. Easy to install as the product comes with inbuilt energy efficient control gear.

Product ID	Watt	CCT	Cutout (mm) \varnothing	Dimension (mm) \varnothing h	MRP
LRC-R 2005	5	3000K/4000K/6000K	64	82 35.5	
LRC-R 2009	9	3000K/4000K/6000K	96	116 36	
LRC-R 2012	12	3000K/4000K/6000K	125	145 36	
LRC-R 2015	15	3000K/4000K/6000K	145	166 36	

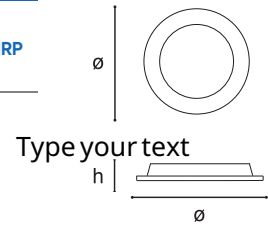

Available Colors

LRC-RA 0009 *Mist Surface Round Ring for 9 watt Rs.125
LRC-RA 0015 *Mist Surface Round Ring for 15 watt Rs. 215



Mist (Sq)



Compact & sleek square LED backlit downlight made up of Polycarbonate housing, high efficacy LEDs, high grade material diffuser to give uniform & glare free output. Easy to install as the product comes with inbuilt energy efficient control gear.

Product ID	Watt	CCT	Cutout (mm) l x b	Dimension (mm) l b h	MRP
LRC-S 2005	5	3000K/4000K/6000K	63 x 63	82 82 35	
LRC-S 2009	9	3000K/4000K/6000K	95 x 95	116 116 36	
LRC-S 2012	12	3000K/4000K/6000K	125 x 125	145 145 36	
LRC-S 2015	15	3000K/4000K/6000K	146 x 146	166 166 36	

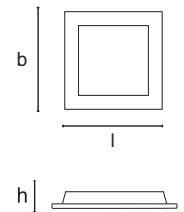

Available Colors

LRC-SA 0009 *Mist Surface Square Ring for 9 watt Rs.125
LRC-SA 0015 *Mist Surface Square Ring for 15 watt Rs.215



Comet (R)



Round trimless COB downlight made of die-cast aluminium housing and robust heat sink for excellent thermal management. It consists of high efficiency reflector to produce excellent light output. Available in Rose Gold, Gold, Silver, White & Black Reflector.

Product ID	Watt	CCT	Beam Angles	Cutout (mm) \varnothing	Dimension (mm) \varnothing h	MRP
LCT 1008	8	3000K/4000K/6000K	50°	88	84 95	
LCT 1012	12	3000K/4000K/6000K	50°	88	84 95	
LCT 1014	14	3000K/4000K/6000K	50°	88	84 95	

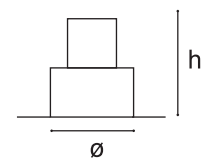

Available Colors

Lego



Recessed COB downlight made up of die-cast aluminium housing & robust heat sink for excellent thermal management, also it offers a wide choice of option for different color reflectors (Rose Gold, Gold, Silver white & Black).

Product ID	Watt	CCT	Beam Angles	Cutout (mm) \varnothing	Dimension (mm) \varnothing h	MRP
LRS 8908	8	3000K/4000K/6000K	50°	80	86.2 90	
LRS 8912	12	3000K/4000K/6000K	50°	80	86.2 90	
LRS 8914	14	3000K/4000K/6000K	50°	80	86.2 90	

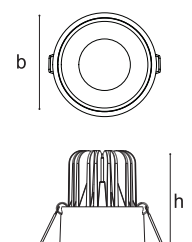

Available Colors

Sol



IP20

Recessed COB down light made of die cast aluminum housing and robust heat sink for excellent thermal management. It consists of high efficiency polycarbonate reflector to produce excellent light output.

Product ID	Watt	CCT	Beam Angles	Cutout (mm) ø	Dimension (mm) ø h	MRP
LHR 5608	8	3000K/4000K/6000K	50°	94	105 101	
LHR 5612	12	3000K/4000K/6000K	50°	94	105 101	
LHR 5614	14	3000K/4000K/6000K	50°	94	105 101	

Available Colors

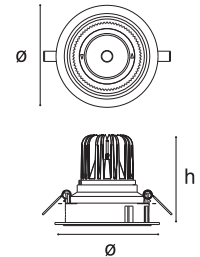

Nova



IP20

Decorative deep COB spot downlight with designer trim and deep recessed reflector to cut glare.

Product ID	Watt	CCT	Beam Angles	Cutout (mm) ø	Dimension (mm) ø h	MRP
LRS 5108	8	3000K/4000K/6000K	50°	93	104.6 96	
LRS 5112	12	3000K/4000K/6000K	50°	93	104.6 96	
LRS 5114	14	3000K/4000K/6000K	50°	93	104.6 96	

Available Colors

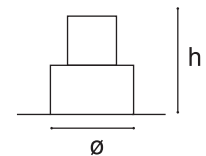

Docco



IP20

Compact styling, clean fascias and enclosed precision die-cast adjustable lamp housing with polycarbonate reflector & energy efficient light sources .

Product ID	Watt	CCT	Beam Angles	Cutout (mm) l x b	Dimension (mm) l b h	MRP
LHR 6108	8	3000K/4000K/6000K	50°	106 x 106	110 110 73	
LHR 6112	12	3000K/4000K/6000K	50°	106 x 106	110 110 73	
LHR 6114	14	3000K/4000K/6000K	50°	106 x 106	110 110 73	

Available Colors

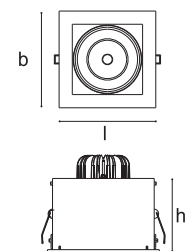

Double Docco



IP20

Twin decorative COB downlight, compact styling, clean fascias and enclosed precision die-cast adjustable lamp housing with polycarbonate reflector & energy efficient light sources .

Product ID	Watt	CCT	Beam Angles	Cutout (mm) l x b	Dimension (mm) l b h	MRP
LHR 6216	16	3000K/4000K/6000K	50°			
LHR 6224	24	3000K/4000K/6000K	50°			
LHR 6228	28	3000K/4000K/6000K	50°			

Available Colors

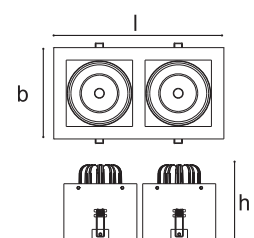

Triple Docco



IP20

Triple decorative COB downlight, compact styling, clean fascias and enclosed precision die-cast adjustable lamp housing with polycarbonate reflector & energy efficient light sources .

Product ID	Watt	CCT	Beam Angles	Cutout (mm) l x b	Dimension (mm) l b h	MRP
LHR 6324	24	3000K/4000K/6000K	50°			
LHR 6336	36	3000K/4000K/6000K	50°			
LHR 6342	42	3000K/4000K/6000K	50°			

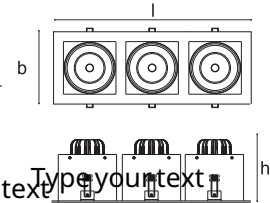

Available Colors

Mika



IP20

High efficient square COB recess downlight encompassing of die-cast aluminium trim and deep recess reflector to cut glare & Suitable for multiple applications. Best optical and thermal solution for high performance.

Product ID	Watt	CCT	Beam Angles	Cutout (mm) l x b	Dimension (mm) l b h	MRP
LRS 9008	8	3000K/4000K/6000K	50°	79 x 94	100 100 87	
LRS 9012	12	3000K/4000K/6000K	50°	79 x 94	100 100 87	
LRS 9014	14	3000K/4000K/6000K	50°	79 x 94	100 100 87	

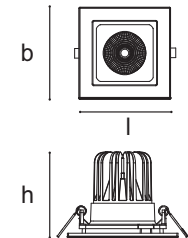

Available Colors

Vela



IP20

The COB wallwasher with softly contoured polycarbonate reflector & energy efficient light source that combines to produce luminaire of exceptional performance.

Product ID	Watt	CCT	Beam Angles	Cutout (mm) ø	Dimension (mm) ø h	MRP
LHR 6508	8	3000K/4000K/6000K	50°	88	96 96	
LHR 6512	12	3000K/4000K/6000K	50°	88	96 96	
LHR 6514	14	3000K/4000K/6000K	50°	88	96 96	

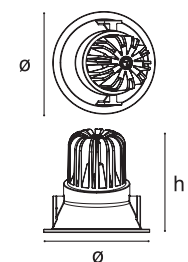

Available Colors

Opal



IP20

Recess adjustable COB downlight made of die-cast aluminium housing and robust heat sink for excellent thermal management. It consists of high efficiency reflector to produce excellent light output.

Product ID	Watt	CCT	Beam Angles	Cutout (mm) ø	Dimension (mm) ø h	MRP
LRS 6008	8	3000K/4000K/6000K	50°	75	88 67	
LRS 6012	12	3000K/4000K/6000K	50°	75	88 67	
LRS 6014	14	3000K/4000K/6000K	50°	75	88 67	
LRS 6020	20	3000K/4000K/6000K	40°	106	120 78	
LRS 6025	25	3000K/4000K/6000K	50°	140	159 95	
LRS 6030	30	3000K/4000K/6000K	50°	140	159 95	
LRS 6035	35	3000K/4000K/6000K	50°	140	159 95	

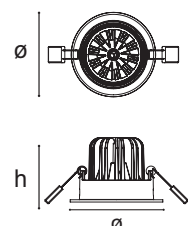

Available Colors

Avio



IP20

The COB spot light with softly contoured reflector and energy efficient light source that combines to produce a luminaire of exceptional style and performance.

Product ID	Watt	CCT	Beam Angles	Cutout (mm) \varnothing	Dimension (mm) \varnothing h	MRP
LRS 7008	8	3000K/4000K/6000K	50°	70	82 79	
LRS 7012	12	3000K/4000K/6000K	50°	70	82 79	
LRS 7014	14	3000K/4000K/6000K	50°	70	82 79	
LRS 7018	18	3000K/4000K/6000K	40°	117	125 95	
LRS 7022	22	3000K/4000K/6000K	40°	117	125 95	

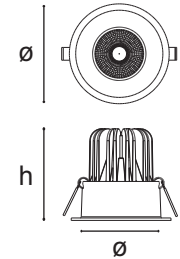

Available Colors

Omega-R



IP20

Recessed COB downlights made of high efficiency die-cast aluminium with powder coated finish. Available with comprehensive choice of color temperatures and wattages.

Product ID	Watt	CCT	Beam Angles	Cutout (mm) \varnothing	Dimension (mm) \varnothing h	MRP
LHR 6720	20	3000K/4000K/6000K	50°	133	145 88	
LHR 6725	25	3000K/4000K/6000K	50°	133	145 88	
LHR 6730	30	3000K/4000K/6000K	50°	133	145 88	

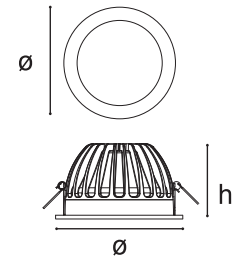

Available Colors

Sigma



IP20

The design features include fully enclosed precision die-cast aluminium construction, excellent pan and tilt adjustment. These adjustable recessed single chip COB downlights consist of high purity aluminium reflector.

Product ID	Watt	CCT	Beam Angles	Cutout (mm) \varnothing	Dimension (mm) \varnothing h	MRP
LHR 6815	15	3000K/4000K/6000K	24°	102	114 98	
LHR 6825	25	3000K/4000K/6000K	35°	129	137 121	
LHR 6835	35	3000K/4000K/6000K	40°	154	163.5 148	
LHR 6845	45	3000K/4000K/6000K	40°	174	190.5 167	

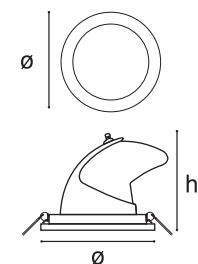

Available Colors

Gia



IP20

Small Recessed COB Round downlight made of die-cast aluminium with powder coating finish. Excellent heat sink capacity to minimize luminous degradation.

Product ID	Watt	CCT	Beam Angles	Cutout (mm) \varnothing	Dimension (mm) \varnothing h	MRP
LRS 8007 (Black Reflector)	7	3000K/4000K/6000K	36°	61	68 66	
LRS 8007 (White Reflector)	7	3000K/4000K/6000K	36°	61	68 66	
LRS 8007 (Copper Reflector)	7	3000K/4000K/6000K	36°	61	68 66	
LRS 8007 (Silver Anodized Reflector)	7	3000K/4000K/6000K	36°	61	68 66	

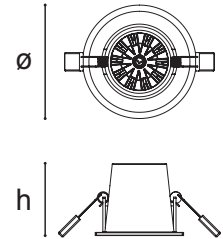

Available Colors

Mia



IP20

Small Recessed COB square downlight made of die-cast aluminium with powder coating finish. Excellent heat sink capacity to minimize luminous degradation.

Product ID	Watt	CCT	Beam Angles	Cutout (mm) l x b	Dimension (mm) l b h	MRP
LRS 8107 (Black Reflector)	7	3000K/4000K/6000K	36°	61 x 61	70 70 63	
LRS 8107 (White Reflector)	7	3000K/4000K/6000K	36°	61 x 61	70 70 63	
LRS 8107 (Copper Reflector)	7	3000K/4000K/6000K	36°	61 x 61	70 70 63	
LRS 8107 (Silver Anodized Reflector)	7	3000K/4000K/6000K	36°	61 x 61	70 70 63	

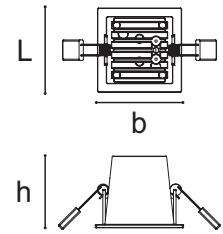

Available Colors

Cribo



IP20

Small adjustable recessed downlight with die-cast aluminium body & reflector with 15 degree tilt option, excellent heat sink capability to minimize luminous degradation.

Product ID	Watt	CCT	Beam Angles	Cutout (mm) \varnothing	Dimension (mm) \varnothing h	MRP
LRS 1205	5	3000K/4000K/6000K	40°	60	66 42	

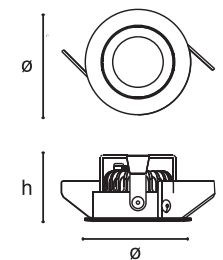

Available Colors

Ziva



IP20

Recessed small COB downlight in circular shape made of die-cast aluminium housing and has robust heat sink for excellent thermal management. It consist of high efficiency reflector to produce excellent light output.

Product ID	Watt	CCT	Beam Angles	Cutout (mm) \varnothing	Dimension (mm) \varnothing h	MRP
LRS 1305	5	3000K/4000K/6000K	40°	52.5	57 38.5	

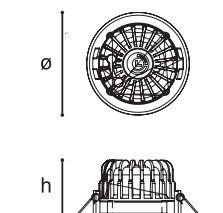

Available Colors

Button



The spotlight combines a sharp design with energy efficient LED module. The high quality lens further enhances the quality of the product which is housed within a die-cast aluminium body.

Product ID	Watt	CCT	Beam Angles	Cutout (mm) \varnothing	Dimension (mm) \varnothing h	MRP
LRS 1002	2	3000K/6000K	20°	29	38 28	Type your text

Available Colors

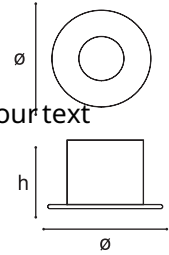

Cell



The spotlight combines a sharp design with energy efficient COB module. It consists of high efficiency chrome plated PC reflector to produce excellent light output which is housed within a die-cast aluminium body.

Product ID	Watt	CCT	Beam Angles	Cutout (mm) \varnothing	Dimension (mm) \varnothing h	MRP
LRS 1403	3	3000K/4000K/6000K	65°	28	38 28	

Available Colors

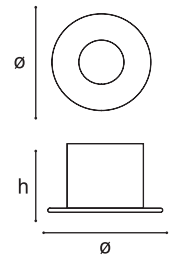

Coral Surface (R)



Surface mount round edge-lit downlight with high efficacy LEDs with highly efficient and low glare diffuser for optimum light distribution.

Product ID	Watt	CCT	Dimension (mm) ø h	MRP
LRS 3106	6	3000K/4000K/6000K	98 43	
LRS 3112	12	3000K/4000K/6000K	160 43	
LRS 3115	15	3000K/4000K/6000K	160 43	
LRS 3118	18	3000K/4000K/6000K	202 48.5	
LRS 3122	22	3000K/4000K/6000K	202 48.5	

Available Colors ●

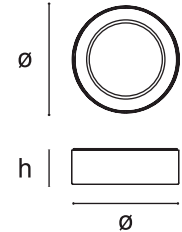

Coral Surface (Sq)



Surface mount square edge-lit downlight with high efficacy LEDs with highly efficient and low glare diffuser for optimum light distribution.

Product ID	Watt	CCT	Dimension (mm) l b h	MRP
LRS 4106	6	3000K/4000K/6000K	102 102 34	
LRS 4112	12	3000K/4000K/6000K	141 141 42	
LRS 4115	15	3000K/4000K/6000K	141 141 42	
LRS 4118	18	3000K/4000K/6000K	191.5 191.5 42	

Available Colors ●

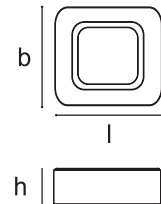

Omega Surface



Surface mount LED downlight. Made of CRCA housing. Specular finished diffuser with high efficient LEDs for better light distribution.

Product ID	Watt	CCT	Dimension (mm) ø h	MRP
LVS 6512	12	3000K/4000K/6000K	149 105	
LVS 6515	15	3000K/4000K/6000K	177.5 107	
LVS 6518	18	3000K/4000K/6000K	177.5 107	

Available Colors ●

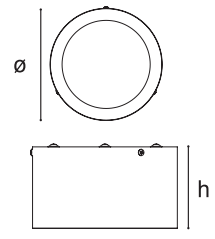

Omega Suspended



Suspended LED downlight. Made of CRCA housing. Specular finished diffuser with high efficient LEDs for better light distribution.

Product ID	Watt	CCT	Dimension (mm) ø h	MRP
LVS 6712	12	3000K/4000K/6000K	149 105	
LVS 6715	15	3000K/4000K/6000K	177.5 107	
LVS 6718	18	3000K/4000K/6000K	177.5 107	

Available Colors ●

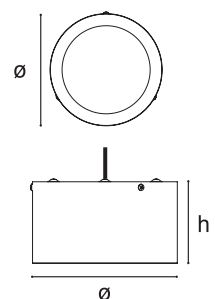

Omega-R Surface



IP20

Surface mount COB downlight with high efficient COB & reflector for better light distribution. Housing made of CRCA.

Product ID	Watt	CCT	Beam Angles	Dimension (mm) ø h	MRP
LVS R 6520	20	3000K/4000K/6000K	50°	148 135	

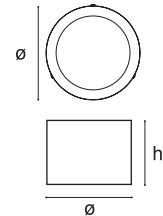

Available Colors ●

Omega-R Suspended



IP20

Suspended COB downlight with high efficient COB & reflector for better light distribution. Housing made of CRCA.

Product ID	Watt	CCT	Beam Angles	Dimension (mm) ø h	MRP
LVS R 6820	20	3000K/4000K/6000K	50°	148 135	

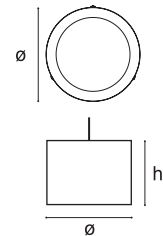

Available Colors ●

Tubo Surface



IP20

Surface mount cylindrical COB downlight with extruded aluminum housing & die casted heat sink. It has efficient COB & reflector for better light distribution suitable for retail, hospitality & residential application area.

Product ID	Watt	CCT	Beam Angles	Dimension (mm) ø h	MRP
LRS 3308	8	3000K/4000K/6000K	50°	63 185	
LRS 3312	12	3000K/4000K/6000K	50°	63 185	
LRS 3318	18	3000K/4000K/6000K	36°	88 200	

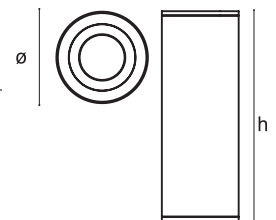

Available Colors ●

Tubo Suspended



IP20

Suspended cylindrical COB downlight with extruded aluminum housing & die casted heat sink. It has efficient COB & reflector for better light distribution suitable for retail, hospitality & residential application area.

Product ID	Watt	CCT	Beam Angles	Dimension (mm) ø h	MRP
LRS-S 3308	8	3000K/4000K/6000K	50°	63 185	
LRS-S 3312	12	3000K/4000K/6000K	50°	63 185	
LRS-S 3318	18	3000K/4000K/6000K	36°	88 200	

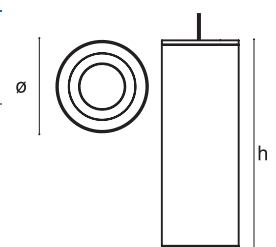

Available Colors ●

Tubo-D Surface



Surface mounted cylindrical COB downlight with extruded aluminum housing & die casted heat sink. It has Diffused light with efficient COB & reflector for better light distribution suitable for retail, hospitality & residential application area.

Product ID	Watt	CCT	Dimension (mm) ø h	MRP
LRS 3408	8	3000K/4000K/6000K	63 185	
LRS 3414	14	3000K/4000K/6000K	63 185	
LRS 3418	18	3000K/4000K/6000K	88 200	

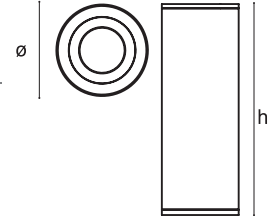

Available Colors ●

Tubo-D Suspended



Suspended cylindrical COB downlight with extruded aluminum housing & die casted heat sink. It has Diffused light with efficient COB & reflector for better light distribution suitable for retail, hospitality & residential application area.

Product ID	Watt	CCT	Dimension (mm) ø h	MRP
LRS-S 3408	8	3000K/4000K/6000K	63 185	
LRS-S 3412	12	3000K/4000K/6000K	63 185	
LRS-S 3418	18	3000K/4000K/6000K	88 200	

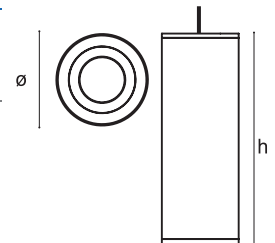

Available Colors ●

Nora



Surface mounted adjustable COB downlight with high efficient COB and reflector for better light distribution suitable for retail, hospitality and residential application area.

Product ID	Watt	CCT	Beam Angles	Dimension (mm) l b h	MRP
LDN 7110	1x10	3000K/4000K/6000K	50°	99 99 109	

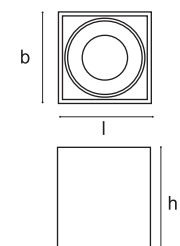

Available Colors ●

Nora Suspended



Suspended mounted adjustable COB downlight with high efficient COB and reflector for better light distribution suitable for retail, hospitality and residential application area.

Product ID	Watt	CCT	Beam Angles	Dimension (mm) l b h	MRP
LDN 7310	1x10	3000K/4000K/6000K	50°	99 99 109	

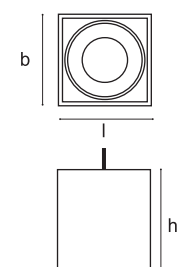

Available Colors ●

Nora-D



Surface mount twin adjustable COB downlight with high efficient COB and reflector for better light distribution suitable for retail, hospitality and residential application area.

Product ID	Watt	CCT	Beam Angles	Dimension (mm) l b h	MRP
LDN 7220	2x10	3000K/4000K/6000K	50°	186 97 109	

Available Colors ●

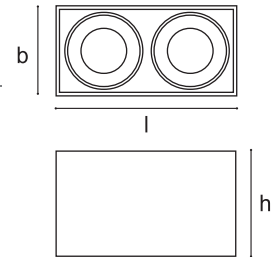

Nora-D Suspended



Suspended mount twin adjustable COB downlight with high efficient COB and reflector for better light distribution suitable for retail, hospitality and residential application area.

Product ID	Watt	CCT	Beam Angles	Dimension (mm) l b h	MRP
LDN 7420	2x10	3000K/4000K/6000K	50°	186 97 109	

Available Colors ●

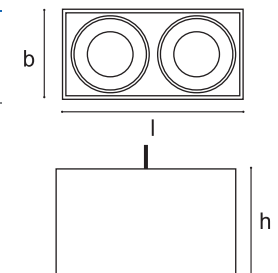

Aura



Organic design with die cast housing & heat sink for efficient heat dissipation. Ideal for retail & hospitality. Curved deep diamond facet reflector with glass to cut glare. Optical and thermal solution for high performance.

Product ID	Watt	CCT	Beam Angles	Dimension (mm) l b h	MRP
LAU 0020	20	3000K/4000K/6000K	36°	191 90 171	
LAU 0025	25	3000K/4000K/6000K	36°	191 90 171	
LAU 0030	30	3000K/4000K/6000K	36°	191 90 171	

Available Colors ●

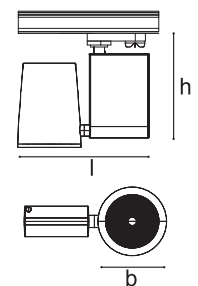

Aura Surface



Surface mounted die-cast housing and heat sink for efficient heat dissipation in surface mounted option. Can be installed directly on ceiling. Curved deep diamond facet reflector with glass to cut glare.

Product ID	Watt	CCT	Beam Angles	Dimension (mm) l b h	MRP
LAU 1020	20	3000K/4000K/6000K	36°	191 90 171	
LAU 1025	25	3000K/4000K/6000K	36°	191 90 171	
LAU 1030	30	3000K/4000K/6000K	36°	191 90 171	

Available Colors ●

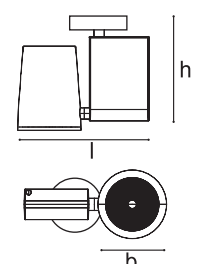

Focus



Surface mounted cylindrical COB adjustable track light with extruded aluminium housing & die-cast aluminium heat sink. It has efficient COB & reflector for better light distribution.

Product ID	Watt	CCT	Beam Angles	Dimension (mm) ø l h	MRP
LSF 3308	8	3000K/4000K/6000K	36°	63 110 125	

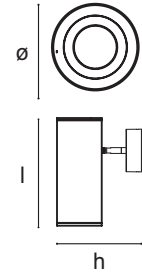

Available Colors ●

Ace



Organic design with die cast housing & heat sink for efficient heat dissipation. Ideal for retail & hospitality. Optical lens with adjustable beam angle for better light distribution. Optical and thermal solution for high performance.

Product ID	Watt	CCT	Dimension (mm) ø l h	MRP
LAC 1015	15	3000K/4000K/6000K	72 160 160	
LAC 1018	18	3000K/4000K/6000K	72 160 160	

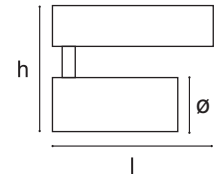

Available Colors ●

Single Phase Track (1m)/(2m)

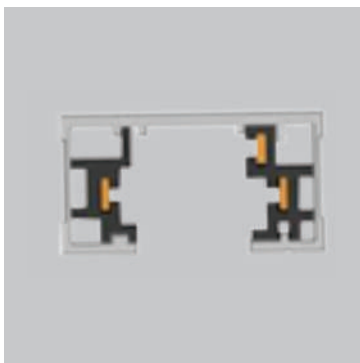

Extruded aluminium construction. Track offers separately controlled circuit with live adaptor & end cap.

Product ID	Track Length	Color	Dimension (mm) l b	MRP
TACT 1001	1m	WHITE	17.8 34.3	
TACT 1002	1m	BLACK	17.8 34.3	
TACT 2001	2m	WHITE	17.8 34.3	
TACT 2002	2m	BLACK	17.8 34.3	

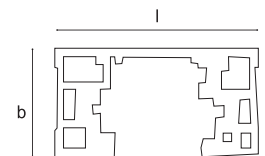

Mini Joiner Single Phase



Join two sections of straight track end to end.

Product ID	Color	Dimension (mm) l b	MRP
TAMJ 001	WHITE	80 34	
TAMJ 002	BLACK	80 34	

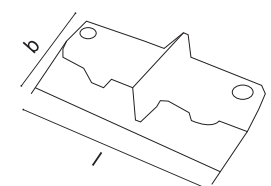

Suspension Kit

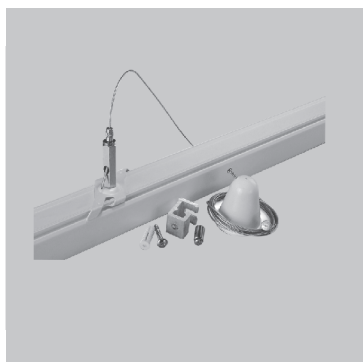

Includes track bracket, rods and suspension wires.

Product ID	CCT	Dimension (mm) l b h	MRP
TASK 3001	WHITE	62 35 59.5	
TASK 3002	BLACK	62 35 59.5	

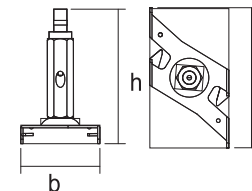

Lynx IP 20



IP20

Flexible LED striplights made of bright LED chips, high quality thermal PCB board and an unmatched quality control process. It is an IP 20 product.

Product ID	Watt	CCT	Dimension (mm) l b h	MRP
LRS 2106	6/meter (60 LED)	3000K/4000K/6000K	5000 8 1.1	
LRS 2514	14/meter (60 LED)	3000K/4000K/6000K	5000 8 1.1	

LRS2105D *12VoltDC2Amp. Driver for 6 watt LEDstriplightper 5 meterroll
 LRS2112D *12VoltDC4Amp. Driver for 14 watt LEDstriplightper 5 meterroll
 LRE101 *Lynx Recessed Extrusion per 1 meter
 LSE102 *Lynx Surface Extrusion per 1 meter
 LCE103 *Lynx Corner Extrusion per 1 meter

Lynx IP 65



IP65

Flexible LED striplights made of bright LED chips, high quality thermal PCB board and an unmatched quality control process. It is an IP 65 product.

Product ID	Watt	CCT	Dimension (mm) b	MRP
LRS 2506	6/meter (60 LED)	3000K/4000K/6000K	5000 14 5	
LRS 2514	14/meter (60 LED)	3000K/4000K/6000K	5000 14 5	

LRS 2206D *Driver for 6watt IP 65 LED strip light per 5 meter (Price on Request)
 LRS2214D *Driver for 14watt IP65 LEDstriplightper 5 meter
 LRE201 *Lynx Recessed Extrusion per 1 meter
 LSE202 *Lynx Surface Extrusion per 1 meter
 LCE203 *Lynx Corner Extrusion per 1 meter

Kiri



IP20

Decorative polycarbonate LED batten in rectangular shape with high efficient PC diffuser & nicely designed end caps.

Product ID	Watt	CCT	Dimension (mm) l b h	MRP
LRS 9110	10	3000K/4000K/6000K	595 22 36.5	
LRS 9920	20	3000K/4000K/6000K	1135 22 36.5	

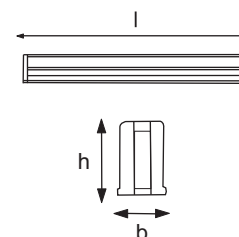

Available Colors ○

Lita



Aluminium extruded LED batten light in square shape with high efficient polycarbonate diffuser for uniform lighting.

Product ID	Watt	CCT	Dimension (mm) l b h	MRP
RBJ 100 0012	12	3000K/4000K/6000K	610 24 38	
RBJ 100 0024	24	3000K/4000K/6000K	1176 24 38	
RBJ 100 0036	36	3000K/4000K/6000K	1176 24 38	

Available Colors ●

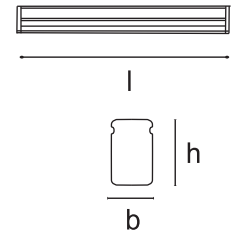

Stripo



The stripo led batten in square shape with aluminium housing & PC end cap. The luminaire and its components are designed for Indoor application. Inbuilt high efficient LEDs used with milky white diffuser for glare free high luminous output.

Product ID	Watt	CCT	Dimension (mm) l b h	MRP
LST 1240	40	3000K/4000K/6000K	1196 35.4 44	

Available Colors ●

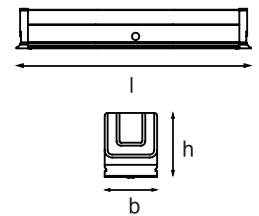

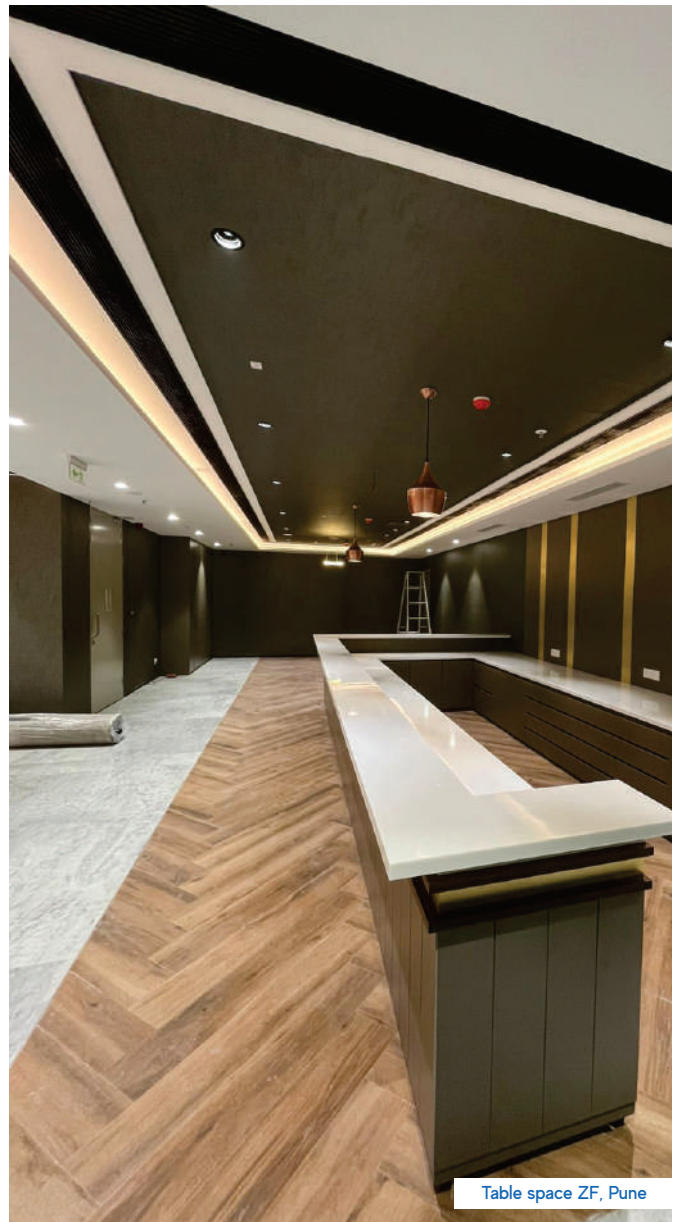



Kalasagar, Pune



LG Showroom, Aurangabad



BMW Showroom, Nepal

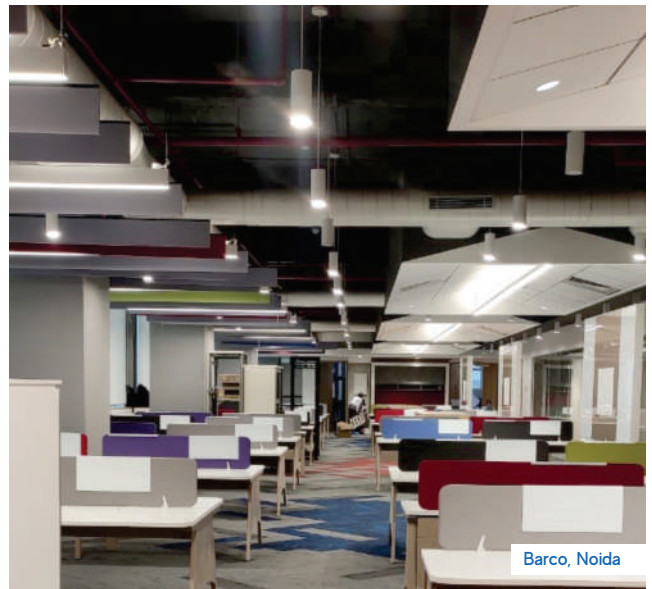

Barco, Noida



Cerence, Hinjewadi



Lake Mall, Kolkata

Terra



IP20

2x2 Recess Mount LED Panel is a very nicely designed product with backlit technology & low height feature to provide high light output and premium aesthetic. It's suitable for the Armstrong/ Grid ceiling.

Product ID	Watt	CCT	Cutout (mm) l x b	Dimension (mm) l b h	MRP
LTP 1036	36	3000K/4000K/6000K	575 x 575	595 595 34	



Available Colors

Modena



IP20

LED recessed grid - ceiling luminaire, suitable for 600 x 600 module and is enclosed with high efficient flat low glare diffuser.

Product ID	Watt	CCT	Cutout (mm) l x b	Dimension (mm) l b h	MRP
LER 2628	28	3000K/4000K/6000K	575 x 575	595 595 76	
LER 2636	36	3000K/4000K/6000K	575 x 575	595 595 76	
LER 2640	40	3000K/4000K/6000K	575 x 575	595 595 76	

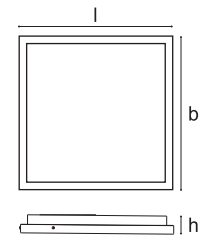

Available Colors

Modena 1x4



IP20

LED ceiling luminaire 1x4 suitable for recessed application with uniform illumination & higher efficiency.

Product ID	Watt	CCT	Cutout (mm) l x b	Dimension (mm) l b h	MRP
LER 1240	40	3000K/4000K/6000K	1175 x 275	1195 295 80	

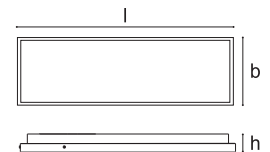

Available Colors

Modena Recessed



IP20

LED recess mount luminaire comes with high efficient low glare diffuser.

Product ID	Watt	CCT	Cutout (mm) l x b	Dimension (mm) l b h	MRP
LER 2518	18	3000K/4000K/6000K	260 x 260	295 295 53	

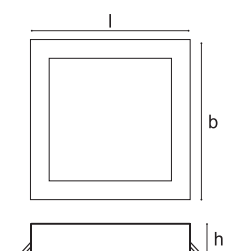

Available Colors

Modena 2 Recessed

LED Recess mount luminaire comes with high efficient flat low glare diffuser.



IP20

Product ID	Watt	CCT	Cutout (mm) l x b	Dimension (mm) l b h	MRP
LER 2524	24	3000K/4000K/6000K	580 x 280	595 298 57	

Available Colors

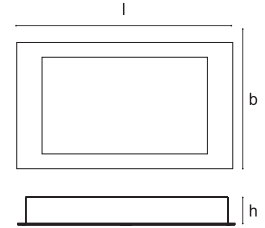

JSS, Faridabad



Accelya, Pune



ICICI Bank, Jaipur

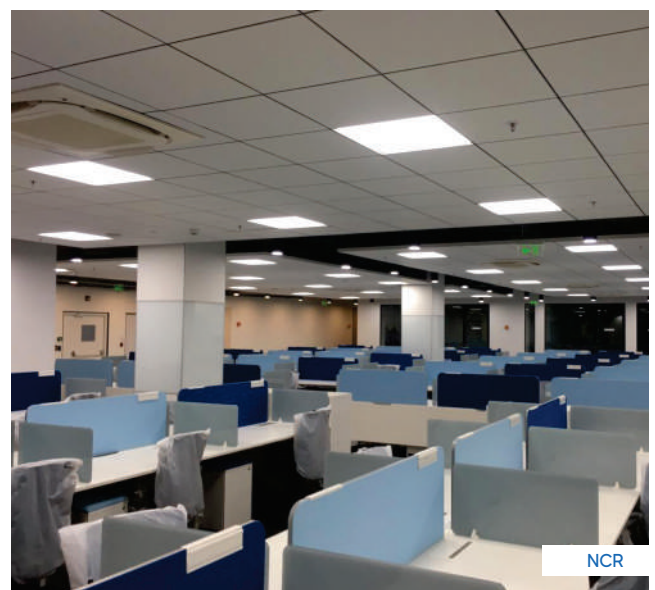

NCR

Moon Light Suspended



IP20

A suspended LED 2x2 luminaire made up of extruded aluminium to give a full glow effect with low glare diffuser and high efficient LEDs.

Product ID	Watt	CCT	Dimension (mm) l b h	MRP
LML 7040	40	3000K/4000K/6000K	595 595 60	

Available Colors

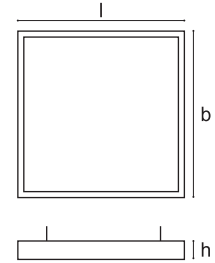

Moon Light Linear 1 Suspended



IP20

A suspended LED 1x4 luminaire made up of extruded aluminium to give a full glow effect with low glare diffuser and high efficient LEDs.

Product ID	Watt	CCT	Dimension (mm) l b h	MRP
LML 7145	45	3000K/4000K/6000K	1195 295 60	

Available Colors

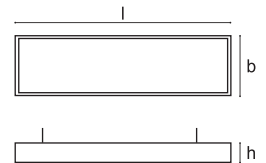

Moon Light Linear 2 Suspended



IP20

A suspended LED 2x4 luminaire made up of extruded aluminium to give a full glow effect with low glare diffuser and high efficient LEDs.

Product ID	Watt	CCT	Dimension (mm) l b h	MRP
LML 7280	80	3000K/4000K/6000K	1195 595 60	

Available Colors

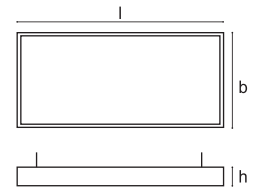

Ribbon



IP20

This contemporary aerial luminaire is a masterpiece that will add a swanky ambiance to your space. The LED fixture features excellent glare-free light distribution and lightweight extruded aluminium housing for an easy installation. Its sleek design and functionality blend in an incredibly eye-catching ribbon-like shape, making a dapper statement while saving you up to 80% on energy costs.

Product ID	Watt	CCT	Dimension (mm) l b h	MRP
LSR 1020	20	3000K/4000K/6000K	1000 70 60	
LSR 1030	30	3000K/4000K/6000K	1000 70 60	

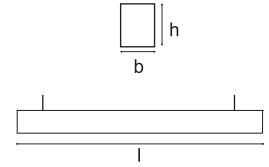

Available Colors

Techpro Direct



IP20

Suspended mounting single length individual luminaire made up of aluminium extruded natural anodized housing with matt finish & PMMA opal diffuser to give uniform light distribution.

Product ID	Watt	CCT	Dimension (mm) l b h	MRP
LTL 1030	30	3000K/4000K/6000K	1195 145 65	

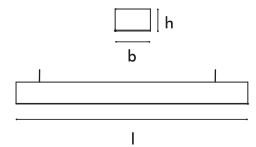

Available Colors

Techpro Up & Down



IP20

Suspended Up & Down single length individual luminaire, aluminium extruded natural anodised housing with matt finish extruded PMMA opal diffuser with uniform light distribution.

Product ID	Watt	CCT	Dimension (mm) l b h	MRP
LTL 2035	35	3000K/4000K/6000K	1195 145 65	

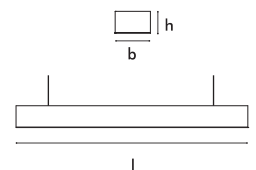

Available Colors

Sonic



IP20

Sonic a perfect suspended design with step in optics offering a combination of functionality and design. A linear lens combination gives a unique look to this product. A aesthetically pleasant product suitable in various applications like offices, restaurants, Showrooms etc.

Product ID	Watt	CCT	Beam Angles	Dimension (mm) l b h	MRP
LPS 5025	25	3000K/4000K/6000K	100°	1177 57.7 85.6	
LPS 5040	40	3000K/4000K/6000K	100°	1177 57.7 85.6	

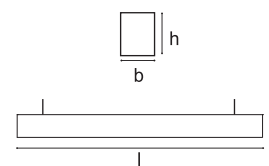

Available Colors

Verge 5



The suspended aluminum extrusion with continuous reflectors optics that offers improved efficiency with focus on reduced UGR. Various customisation available with prismatic lens in cell louvers gives flexible light option to the product.

Product ID	Watt	CCT	Beam Angles	Dimension (mm) b h	MRP
LPV 5130	30	3000K/4000K/6000K	35°	1186 57.7 85.6	

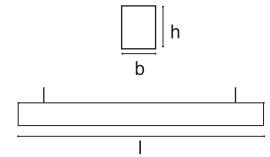

Available Colors

Verge 3



The suspended aluminum extrusion with three reflectors module optics that offers improved efficiency with focus on reduced UGR. Various customisation available with prismatic lens in cell louvers gives flexible light option to the product.

Product ID	Watt	CCT	Beam Angles	Dimension (mm) b h	MRP
LPV 5130	30	3000K/4000K/6000K	35°	1215 57.7 85.6	

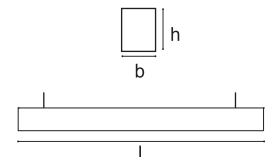

Available Colors

Tulip



Tulip a suspended extruded aluminium housing design offers improved uniformity with soft C profile LG7 diffuser lit on all three sides offering a soft homogeneous, volumetric light distribution snap fit diffuser for ease in maintenance.

Product ID	Watt	CCT	Dimension (mm) b h	MRP
LSO 5020	20	3000K/4000K/6000K	1200 50.5 75	
LSO 5030	30	3000K/4000K/6000K	1200 50.5 75	
LSO 5040	40	3000K/4000K/6000K	1200 50.5 75	

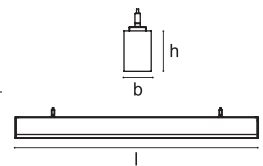

Available Colors

Strapline 50 Up & Down



The extruded aluminium housing offers a precise in-line appearance. This LED fixture comes with Direct-Indirect light distribution, high wired LED driver to be used in suspended applications.

Product ID	Watt	CCT	Dimension (mm) b h	MRP
LSL-S 5130	30	3000K/4000K/6000K	1000/1200 52.8 101	
LSL-S 5140	40	3000K/4000K/6000K	1000/1200 52.8 101	

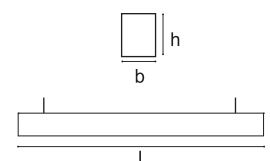

Available Colors

Strapline 50 Suspended



IP20

The extruded aluminium housing offers a precise in-line appearance. This LED fixture comes with excellent light distribution, high wired LED driver to be used in suspended/surface applications.

Product ID	Watt	CCT	Dimension (mm) l b h	MRP
LSL-S 5020	20	3000K/4000K/6000K	1000/1200 53 80	
LSL-S 5030	30	3000K/4000K/6000K	1000/1200 53 80	
LSL-S 5040	40	3000K/4000K/6000K	2000/2400 53 80	
LSL-S 5060	60	3000K/4000K/6000K	2000/2400 53 80	

Available Colors

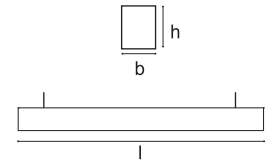

Strapline 50 Recessed



IP20

The extruded aluminium housing offers a precise in-line appearance. This LED fixture comes with excellent light distribution, high wired LED driver and mounting clamps to be used in recessed application.

Product ID	Watt	CCT	Cutout (mm) l x b	Dimension (mm) l b h	MRP
LSL-R 5020	20	3000K/4000K/6000K	992/1192 55		
LSL-R 5030	30	3000K/4000K/6000K	992/1192 55		
LSL-R 5040	40	3000K/4000K/6000K	1992/2392 55		
LSL-R 5060	60	3000K/4000K/6000K	1992/2392 55		

Available Colors

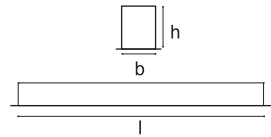

Strapline 35 Suspended



IP20

The extruded aluminium housing offers a precise in-line appearance. This LED fixture comes with excellent light distribution, high wired LED driver to be used in suspended/surface applications.

Product ID	Watt	CCT	Dimension (mm) l b h	MRP
LSL-S 3520	20	3000K/4000K/6000K	1200 36.5 53	
LSL-S 3530	30	3000K/4000K/6000K	1200 36.5 53	
LSL-S 3540	40	3000K/4000K/6000K	2400 36.5 53	
LSL-S 3560	60	3000K/4000K/6000K	2400 36.5 53	

Available Colors

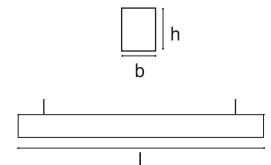

Strapline 35 Recessed



IP20

The extruded aluminium housing offers a precise in-line appearance. This LED fixture comes with excellent light distribution, high wired LED driver and mounting clamps to be used in recessed application.

Product ID	Watt	CCT	Cutout (mm) l x b	Dimension (mm) l b h	MRP
LSL-R 3520	20	3000K/4000K/6000K	1192 38	1200 46.5 57	
LSL-R 3530	30	3000K/4000K/6000K	1192 38	1200 46.5 57	
LSL-R 3540	40	3000K/4000K/6000K	2392 38	2400 46.5 57	
LSL-R 3560	60	3000K/4000K/6000K	2392 38	2400 46.5 57	

Available Colors

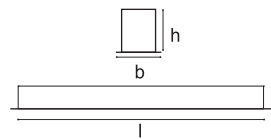

Pill Suspended



IP20

Round extruded aluminium housing with PMMA diffuser. High efficient LEDs for uniform light distribution .

Product ID	Watt	CCT	Dimension (mm) ø h	MRP
ALP-S 4130	30	3000K/4000K/6000K	400 60	
ALP-S 5145	45	3000K/4000K/6000K	500 60	
ALP-S 6156	56	3000K/4000K/6000K	600 60	
ALP-S 9180	80	3000K/4000K/6000K	900 60	
ALP-S 12100	100	3000K/4000K/6000K	1170 60	

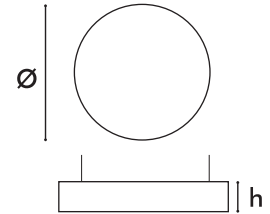

Available Colors

Pill Recessed



IP20

Round luminaire aluminium, rolled profile, seamlessly welded housing with integrated tool-less suspension height adjustment. Highly reflective coating for improved efficiency with high transmission factor PMMA opal diffuser. Rolled aluminium frame accessory along with fixture for ease in installation.

Product ID	Watt	CCT	Cutout (mm) ø	Dimension (mm) ø h	MRP
ALP-R 4230	30W	3000K/4000K/6000K	410	400 65	
ALP-R 5245	45W	3000K/4000K/6000K	510	500 65	
ALP-R 6256	56W	3000K/4000K/6000K	610	600 65	

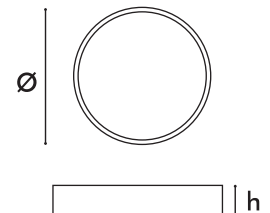

Available Colors

Pill Surface



IP20

Round luminaire aluminium, rolled profile, seamlessly welded housing with integrated tool-less suspension height adjustment. Highly reflective coating for improved efficiency with high transmission factor diffuser. Rolled aluminium frame accessory along with fixture for ease in installation.

Product ID	Watt	CCT	Dimension (mm) ø h	MRP
ASP 4330	30	3000K/4000K/6000K	400 110	
ASP 5345	45	3000K/4000K/6000K	500 110	
ASP 6350	50	3000K/4000K/6000K	600 110	
ASP 9380	80	3000K/4000K/6000K	900 110	

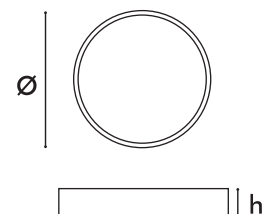

Available Colors

Ripple

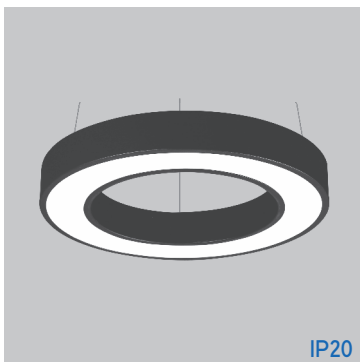

IP20

Round extruded aluminium housing with diffuser. Smart circular ring gives functional decorative look. Also diffuser is so fixed to provide uniform light output.

Product ID	Watt	CCT	Dimension (mm) ø h	MRP
ARL 6030	30	3000K/4000K/6000K	600 60	
ARL 9055	55	3000K/4000K/6000K	900 60	
ARL 12080	80	3000K/4000K/6000K	1170 60	
ARL 15000		3000K/4000K/6000K	1500 60	
ARL 18000	As per Request	3000K/4000K/6000K	1800 60	
ARL 20000		3000K/4000K/6000K	2000 60	
ARL 24000		3000K/4000K/6000K	2400 60	

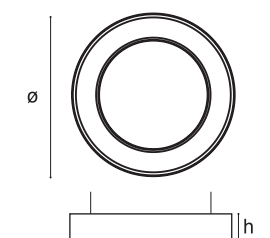

Available Colors

Crescent



Extruded Aluminum housing in Circular Arc form with high transmissivity Diffuser. High efficient LEDs with uniform light distribution.

Product ID	Watt	CCT	Dimension (mm) l b h	MRP
ACL 6030	30	3000K/4000K/6000K	801.3 301.6 60	

Available Colors

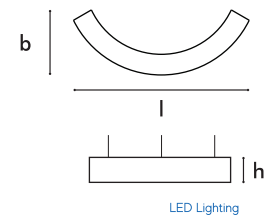

Trio



Triangular extruded aluminium housing with soft corner and high transmissivity diffuser. High efficient LEDs for uniform light.

Product ID	Watt	CCT	Dimension (mm) l b h	MRP
ATL-S 3030	30W	3000K/4000K/6000K	511 450 60	

Available Colors

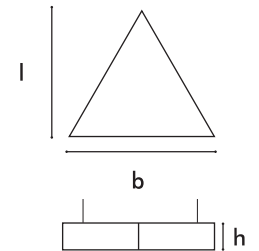

Hexo



The extruded aluminium housing in hexagon shape with high transmissivity diffuser. High efficient LEDs for uniform light distribution.

Product ID	Watt	CCT	Dimension (mm) l b h	MRP
AHL 6040	40	3000K/4000K/6000K	672 582 60	

Available Colors

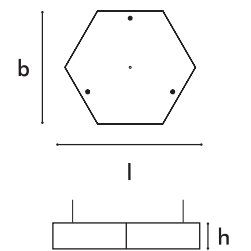

Recto



Rectangular shape extruded aluminium housing with high transmissivity diffuser gives functional look. Also high efficient LEDs & diffuser combination gives smooth & uniform light.

Product ID	Watt	CCT	Dimension (mm) l b h	MRP
ARL 6330	30	3000K/4000K/6000K	600 300 60	

Available Colors

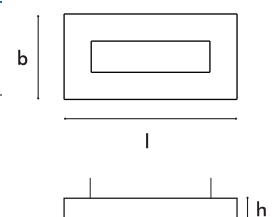

Frame



Square extruded aluminium housing with high transmissivity diffuser. Geometrical shape blends perfectly with ceiling design & gives unique product look.

Product ID	Watt	CCT	Dimension (mm) l b h	MRP
AFL 5030	30	3000K/4000K/6000K	500 500 60	

Available Colors

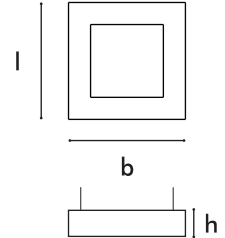

Petal



Extruded aluminium housing designed in leaf shape for unique & decorative look. High transmissivity diffuser is used to give smooth & glare free light output.

Product ID	Watt	CCT	Dimension (mm) l b h	MRP
APL 6330	30W	3000K/4000K/6000K	609 307 60	

Available Colors

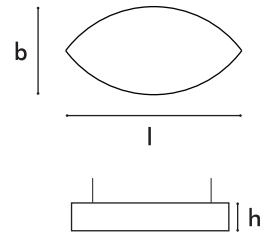

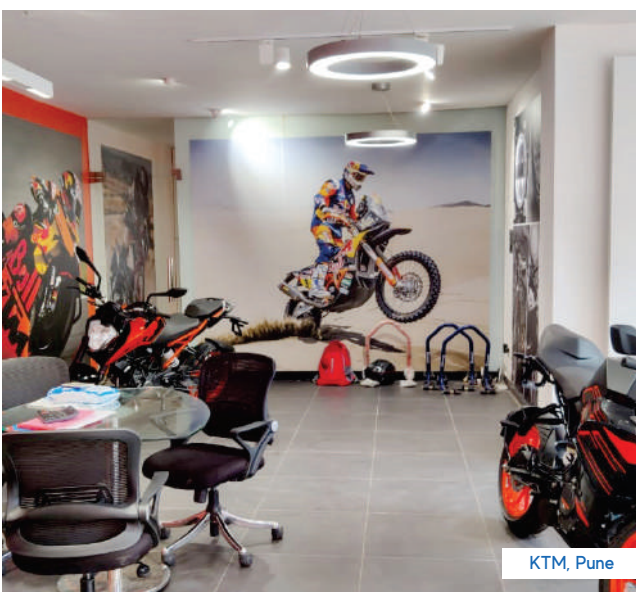



Ecolab, Pune



IGI Airport-T3, Delhi

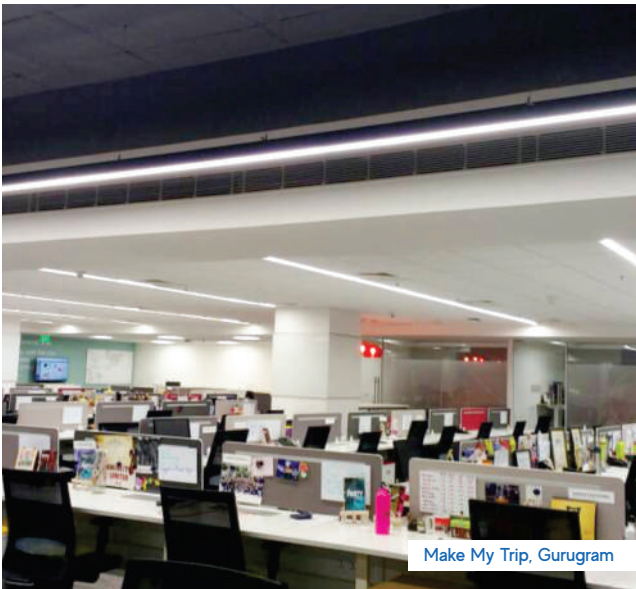

Make My Trip, Gurugram



Kalyan Mantapa, Bangalore



LG Chem, Gurugram



Compu Com, Pune

Blaze



The BLAZE modular Highbay is a hassle free replacement of general highbay in industries. Blaze comes with light efficacy of 150 lm/w & customized LED Light module and various precision lens optics packages. Blaze comes with decorative design and multiple color option. Aluminum die-cast module with unique designed heat sink fins provide thermal management to natural convection. Decorative Polycarbonate End caps give an aesthetic appeal to the product. Various hanging angles are provided in the mounting clamp for mounting light in different angles. Each module comes with its separate driver section. Precision lens optic system optimizes illumination for open floor, racked or aisle way applications.

Product ID	Watt	CCT	Beam Angles	Dimension (mm) l b h	MRP
LBL-N 040	40	5700K	60°/90°	217 228 100	
LBL-N 050	50	5700K	60°/90°	217 228 100	

Available Colors ●

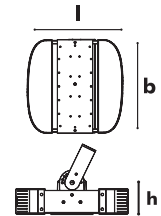

Blaze



The BLAZE modular Highbay is a hassle free replacement of general highbay in industries. Blaze comes with light efficacy of 150 lm/w & customized LED Light module and various precision lens optics packages. Blaze comes with decorative design and multiple color option. Aluminum die-cast module with unique designed heat sink fins provide thermal management to natural convection. Decorative Polycarbonate End caps give an aesthetic appeal to the product. Various hanging angles are provided in the mounting clamp for mounting light in different angles. Each module comes with its separate driver section. Precision lens optic system optimizes illumination for open floor, racked or aisle way applications.

Product ID	Watt	CCT	Beam Angles	Dimension (mm) l b h	MRP
LBL-N 080	80	5700K	60°/90°	325 228 100	
LBL-N 0100	100	5700K	60°/90°	325 228 100	

Available Colors ●

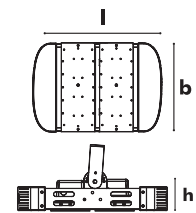

Blaze



The BLAZE modular Highbay is a hassle free replacement of general highbay in industries. Blaze comes with light efficacy of 150 lm/w & customized LED Light module and various precision lens optics packages. Blaze comes with decorative design and multiple color option. Aluminum die-cast module with unique designed heat sink fins provide thermal management to natural convection. Decorative Polycarbonate End caps give an aesthetic appeal to the product. Various hanging angles are provided in the mounting clamp for mounting light in different angles. Each module comes with its separate driver section. Precision lens optic system optimizes illumination for open floor, racked or aisle way applications.

Product ID	Watt	CCT	Beam Angles	Dimension (mm) l b h	MRP
LBL-N 0120	120	5700K	60°/90°	422 228 100	
LBL-N 0150	150	5700K	60°/90°	422 228 100	

Available Colors ●

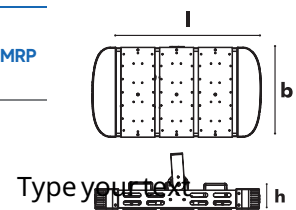

Blaze



The BLAZE modular Highbay is a hassle free replacement of general highbay in industries. Blaze comes with light efficacy of 150 lm/w & customized LED Light module and various precision lens optics packages. Blaze comes with decorative design and multiple color option. Aluminum die-cast module with unique designed heat sink fins provide thermal management to natural convection. Decorative Polycarbonate End caps give an aesthetic appeal to the product. Various hanging angles are provided in the mounting clamp for mounting light in different angles. Each module comes with its separate driver section. Precision lens optic system optimizes illumination for open floor, racked or aisle way applications.

Product ID	Watt	CCT	Beam Angles	Dimension (mm) l b h	MRP
LBL-N 0200	200	5700K	60°/90°	522 228 100	

Available Colors ●

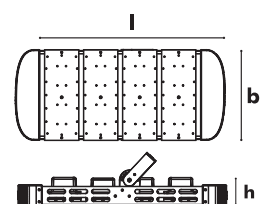

Delphi



IP66

Elegant round High bay luminaire design along with lens & toughened glass which is designed to replace traditional High bays. The system delivers simple, point to point replacement with easy installation methods of hook, pendants and brackets. Unique matt finish powder coating gives alluring look to the fixture. A Multi electronic driver in the housing provides extra performance and unique feature to the product.

Product ID	Watt	CCT	Beam Angles	Dimension (mm) ø h	MRP
LDH 060	60	3000K/4000K/5700K	60°/90°	275 122	
LDH 080	80	3000K/4000K/5700K	60°/90°	275 122	
LDH 100	100	3000K/4000K/5700K	60°/90°	275 122	

Available Colors ●

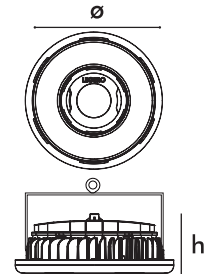

Roto



IP66

Elegant round Highbay luminaire design along with lenses & glasses is designed to replace traditional Highbays. The system delivers simple, point to point replacement with easy installation methods of hook, pendants and brackets. Unique matt finish powder coating gives alluring look to the fixture.

Product ID	Watt	CCT	Beam Angles	Dimension (mm) ø h	MRP
LRO 080	80	3000K/5700K	60°/90°	276 140	
LRO 100	100	3000K/5700K	60°/90°	320 130	
LRO 120	120	3000K/5700K	60°/90°	320 130	
LRO 150	150	3000K/5700K	60°/90°	365 150	
LRO 200	200	3000K/5700K	60°/90°	365 150	

Available Colors ●

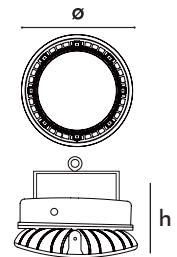

Roto 2



IP66

Elegant round Highbay luminaire design along with lens module. The system delivers simple, point to point replacement with easy installation methods of hook, pendants and brackets. Unique matt finish powder coating gives alluring look to the fixture.

Product ID	Watt	CCT	Beam Angles	Dimension (mm) ø h	MRP
LRO 2080	80	3000K/5700K	90°	276 140	
LRO 2100	100	3000K/5700K	90°	320 130	
LRO 2120	120	3000K/5700K	90°	320 130	
LRO 2150	150	3000K/5700K	90°	365 150	
LRO 2200	200	3000K/5700K	90°	365 150	

Available Colors ●

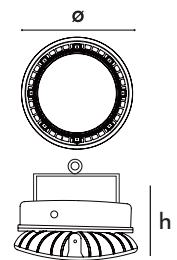

Axel



IP66

Axel is an Innovative LED well glass luminaire for direct replacement of 100W Conventional Fixture. Axel has the potential to save up to 60% of energy without compromising lighting parameters in the existing installation. Axel is widely used in various applications in diversified sector. It is developed by using advance technology and requisition tool in compliance with quality standards. Available in both opal & clear vandal resistant polycarbonate diffuser.

Product ID	Watt	CCT	Dimension (mm) ø h	MRP
LAX-O 040 (Opal)	40	6000K	120 180	
LAX-O 040 (Clear)	40	6000K	120 180	

Available Colors ●

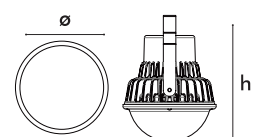

Strix



The Strix (Industrial Batten) is the highly efficient and reliable IP65 led lighting solution. The luminaire and its components are designed for Indoor & Outdoor application. Inbuilt high efficient LEDs used with PC housing & milky white diffuser for glare free luminous output.

Product ID	Watt	CCT	Dimension (mm) l b h	MRP
LSB 1220	20	3000K/4000K/6000K	633 54 53	
LSB 1240	40	3000K/4000K/6000K	1217 54 53	

Suspension Kit - Rs. 550

Available Colors

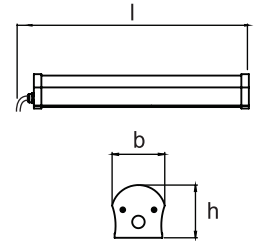

Astra-LW



ASTRA-LW Floodlight is a universal, compact range of floodlights with two type of beam angle lens. The range is suitable for various applications around buildings, ideal for facade lighting as well as lighting gardens, paths near to buildings, garages, entrance ways, security lighting and drives. This IP 66 product comes with fixture efficacy of 110 lm/w.

Product ID	Watt	CCT	Beam Angles	Dimension (mm) l b h	MRP
LAS 0030	30	3000K/5700K	60°/90°	181 141 112	
LAS 0050	50	3000K/5700K	60°/90°	181 141 112	

Available Colors

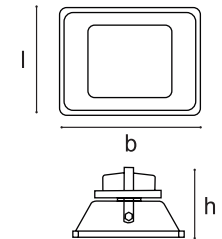

Astra-MW



ASTRA-MW Floodlight is a universal, compact range of floodlights with two type of beam angle lens. The range is suitable for various applications around buildings, ideal for facade lighting as well as lighting gardens, paths near to buildings, garages, entrance ways, security lighting and drives. This IP 66 product comes with fixture efficacy of 110 lm/w.

Product ID	Watt	CCT	Beam Angles	Dimension (mm) l b h	MRP
LAS 0100	100	3000K/5700K	60°/90°	270 220 128	
LAS 0150	150	3000K/5700K	60°/90°	365 265 122	
LAS 0200	200	3000K/5700K	60°/90°	365 265 122	

Available Colors

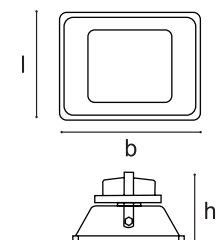

Astra-HW



ASTRA-HW Floodlight is a universal, compact range of floodlights with two type of beam angle lens. The range is suitable for various applications around buildings, ideal for facade lighting as well as lighting gardens, paths near to buildings, garages, entrance ways, security lighting and drives. This IP 66 product comes with fixture efficacy of 110 lm/w.

Product ID	Watt	CCT	Beam Angles	Dimension (mm) l b h	MRP
LAS 0250	250	3000K/5700K	60°/90°	428 327 160	
LAS 0300	300	3000K/5700K	60°/90°	428 327 160	
LAS 0350	350	3000K/5700K	60°/90°	520 330 165	
LAS 0400	400	3000K/5700K	60°/90°	520 330 165	

Available Colors

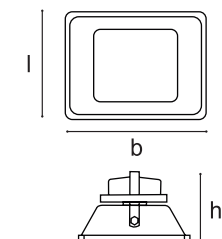

Beam



IP66

IP 66 LED flood light with Elegant squarish design with modular lens. Powder coated finish with cradle mounting facility.

Product ID	Watt	CCT	Beam Angles	Dimension (mm) l b h	MRP
LSK 1030	30	6000K	75°	197 188 37	
LSK 1050	50	6000K	75°	238 228 37	
LSK 1100	100	6000K	60°	292 282 50	
LSK 1200	200	6000K	75°	363 352 50	

Available Colors ●

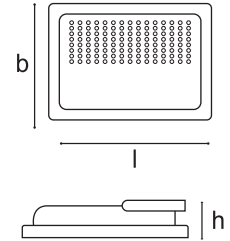

Bento



IP66

IP 66 LED street light with high pressure aluminium die-cast body and toughened glass. Powered with high efficacy LED chips to give the best output.

Product ID	Watt	CCT	Beam Angles	Pole Dia (mm) ø	Dimension (mm) l b h	MRP
LRS 99020	20	6000K	100°	40	320 110 60	
LRS 99025	25	6000K	100°	40	320 110 60	
LRS 99030	30	6000K	100°	40	320 110 60	

Available Colors ●

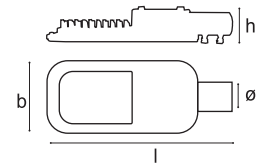

Bento



IP66

IP 66 LED street light with high pressure aluminium die-cast body and toughened glass. Powered with high efficacy LED chips to give the best output. Back driver opening suitable for easy replacement.

Product ID	Watt	CCT	Beam Angles	Pole Dia (mm) ø	Dimension (mm) l b h	MRP
LRS 99040	40	6000K	100°	42	385 155 62	
LRS 99050	50	6000K	100°	42	385 155 62	
LRS 99060	60	6000K	105°	54	400 210 76	
LRS 99070	70	6000K	105°	54	400 210 76	
LRS 99090	90	6000K	110°	54	400 210 76	

Available Colors ●

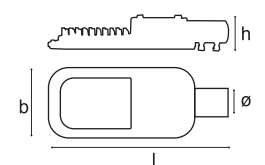

Cleo



IP66

IP 66 LED street light with high pressure aluminium die cast body and lens toughened glass. Powered with high power LED chips to give the best output. Cleo comes with light efficacy of 110 lm/w. Wider spread angle of lens with toughened glass provide extra coverage of light on road.

Product ID	Watt	CCT	Beam Angles	Pole Dia (mm) ø	Dimension (mm) l b h	MRP
LCL 0018	18	5700K	125° x 45°	40	320 110 60	
LCL 0024	24	5700K	125° x 45°	40	320 110 60	
LCL 0036	36	5700K	125° x 45°	42	385 155 62	
LCL 0045	45	5700K	125° x 55°	42	385 155 62	

Available Colors ●

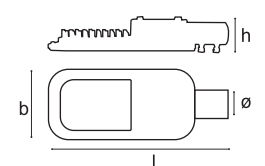

Cleo



Unique designed Street light with High Power LED and back/front driver opening comes with all the options suitable for lighting outdoor application. Wider spread angle of lens with toughened glass provide extra coverage of light on roads. Aluminium Die cast Housing with unique heat sink fins structure provides thermal management to natural convection. This IP 66 product comes with fixture efficacy of 110 lm/w.

Product ID	Watt	CCT	Beam Angles	Pole Dia (mm) \varnothing	Dimension (mm) \varnothing h	MRP
LCL 0060	60	5700K	145° x 65°	54	400 210 76	
LCL 0072	72	5700K	145° x 65°	54	400 210 76	
LCL 0090	90	5700K	145° x 55°	54	400 210 76	
LCL 0110	110	5700K	145° x 60°	50	400 195 100	
LCL 0140	140	5700K	145° x 60°	50	440 230 108	
LCL 0190	190	5700K	145° x 60°	60	502 257 108	

Available Colors ●

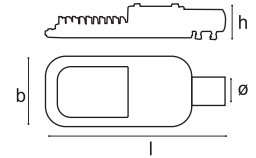

Mantis



An ultra compact, IP 66, LED light luminaire. Its corrosion proof, die cast aluminium composite construction makes it ideal for the harshest corrosive environment. Spike available to ease the installation.

Product ID	Watt	CCT	Beam Angles	Dimension (mm) \varnothing l h	MRP
LSM 1007	7	3000K/4000K/6000K	40°	49 110 255	

Available Colors ●

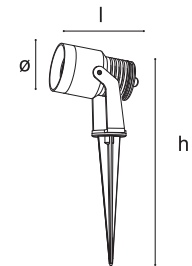

Pictor



An ultra compact, IP 66, LED light luminaire. Its corrosion proof, die cast aluminium composite construction makes it ideal for the harshest corrosive environment. Spike available to ease the installation.

Product ID	Watt	CCT	Beam Angles	Dimension (mm) \varnothing l h	MRP
LSO 3010	10	3000K	50°	75 138 245	
LSO 3015	15	3000K	50°	75 138 245	

Available Colors ●

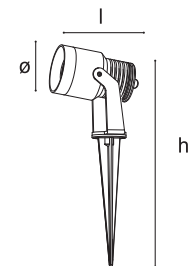

Oreon



Cylindrical type wall mounted IP 65 luminaire made of high grade aluminium extrusion & die cast aluminium heatsink for effective heat dissipation with high efficient COB for better output. The luminaire comes with toughened glass.

Product ID	Watt	CCT	Beam Angles	Dimension (mm) \varnothing l h	MRP
LCO 4408	8	3000K/4000K/6500K	50°	80 115 192	
LCO 4412	12	3000K/4000K/6500K	50°	80 115 192	
LCO 4415	15	3000K/4000K/6500K	50°	80 115 192	

Available Colors ●

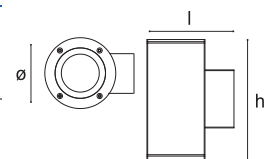

Oreon Up & Down



Cylindrical type wall mounted IP 65 up-down luminaire made of high grade aluminium extrusion & die cast aluminium heatsink for effective heat dissipation with high efficient COB for better output. The luminaire comes with toughened glass.

Product ID	Watt	CCT	Beam Angles	Dimension (mm) ø l h	MRP
LCO 4516	2x8	3000K/4000K/6500K	50°	80 115 200	
LCO 4524	2x12	3000K/4000K/6500K	50°	80 115 240	
LCO 4530	2x15	3000K/4000K/6500K	50°	80 115 240	

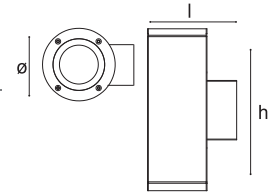

Available Colors ●

Oreon Surface



Cylindrical type ceiling mounted IP 65 luminaire made of high grade aluminium extrusion & die cast aluminium heatsink for effective heat dissipation with high efficient COB for better output. The luminaire comes with toughened glass.

Product ID	Watt	CCT	Beam Angles	Dimension (mm) ø h	MRP
LCO 4308	8	3000K/4000K/6500K	50°	80 186	
LCO 4312	12	3000K/4000K/6500K	50°	80 186	
LCO 4315	15	3000K/4000K/6500K	50°	80 186	

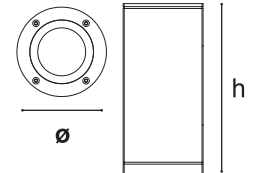

Available Colors ●

Kube



Rectangular type wall mounted IP 65 luminaire made of high grade aluminium extrusion & die cast aluminium heatsink for effective heat dissipation with high efficient COB for better output. The luminaire comes with toughened glass.

Product ID	Watt	CCT	Beam Angles	Dimension (mm) l b h	MRP
LSO 3207	8	3000K/4000K/6500K	50°	80 120 192	
LSO 3212	12	3000K/4000K/6500K	50°	80 120 192	
LSO 3215	15	3000K/4000K/6500K	50°	80 120 192	

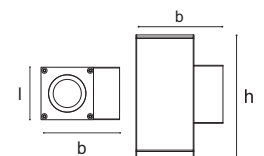

Available Colors ●

Kube Up & Down



Rectangular type wall mounted IP 65 up-down luminaire made of high grade aluminium extrusion & die cast aluminium heatsink for effective heat dissipation with high efficient COB for better output. The luminaire comes with toughened glass.

Product ID	Watt	CCT	Beam Angles	Dimension (mm) l b h	MRP
LSO 3316	2x8	3000K/4000K/6500K	50°	80 115 198	
LSO 3324	2x12	3000K/4000K/6500K	50°	80 115 198	
LSO 3330	2x15	3000K/4000K/6500K	50°	80 115 198	

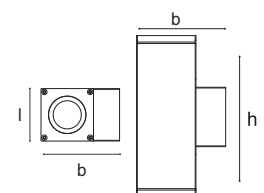

Available Colors ●

Kube Surface



IP65

Rectangular type ceiling mounted IP 65 luminaire made of high grade aluminium extrusion & die cast aluminium heatsink for effective heat dissipation with high efficient COB for better output. The luminaire comes with toughened glass.

Product ID	Watt	CCT	Beam Angles	Dimension (mm) b h	MRP
LSO 3408	8	3000K/4000K/6500K	50°	80 80 186	
LSO 3412	12	3000K/4000K/6500K	50°	80 80 186	
LSO 3415	15	3000K/4000K/6500K	50°	80 80 186	

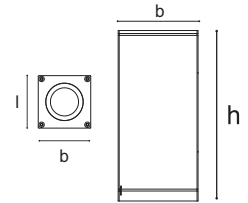

Available Colors ●

Sia



IP65

IP 65 SIA (bulk head) light is integrated with high efficient LEDs with milky diffuser covering. The fixture has integrated driver and is easy on maintenance.

Product ID	Watt	CCT	Dimension (mm) b h	MRP
LBH 0012	12	6000K	189 109 67	
LBH 0015	15	6000K	189 109 67	
LBH 0018	18	6000K	189 109 67	

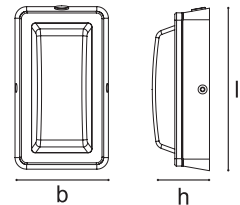

Available Colors ●

Edge



IP65

Square IP65 Edge (Steplight) is integrated with high efficient LEDs with die-cast aluminium housing & clear glass to achieve better light distribution.

Product ID	Watt	CCT	Cutout (mm) x b x h	Dimension (mm) b h	MRP
LSA 3003	3	3000K/4000K/6000K	78 x 73 x 40	84 84 43	

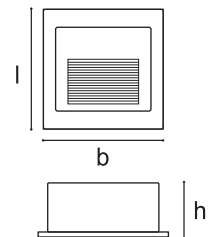

Available Colors ●

Brick



IP65

IP 65 designer step light with integrated high efficient LED designed for safety & style for stairways, patios, decks, balcony areas & walkways.

Product ID	Watt	CCT	Dimension (mm) b h	MRP
LOD 3004	4	3000K/4000K/6000K	99 99 61	
LOD 3006	6	3000K/4000K/6000K	99 99 61	

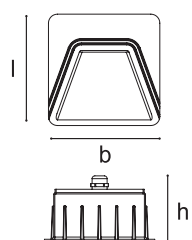

Available Colors ●

Elava



IP 67 in ground LED luminaire die cast housing stainless steel cover, anti-corrosion resistant, tempered clear glass with optical lens & Integrated driver.

Product ID	Watt	CCT	Beam Angles	Cutout (mm) ø	Dimension (mm) ø h	MRP
LOD 44501	1	3000K/4000K/6000K	16°/24°/36°	45.8	49 90.5	

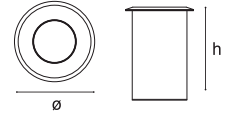

Available Colors ●

Elava



IP 67 in ground LED luminaire die cast housing stainless steel cover, anti-corrosion resistant, tempered clear glass with optical lens & Integrated driver.

Product ID	Watt	CCT	Beam Angles	Cutout (mm) ø	Dimension (mm) ø h	MRP
LOD 44503	3	3000K/4000K/6000K	16°/24°/36°	77.8		
LOD 44509	9	3000K/4000K/6000K	16°/24°/36°	77.8		

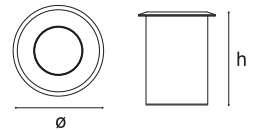

Available Colors ●

Type your text

Elava



IP 67 in ground LED luminaire die cast housing stainless steel cover, anti-corrosion resistant, tempered clear glass with optical lens & Integrated driver.

Product ID	Watt	CCT	Beam Angles	Cutout (mm) ø	Dimension (mm) ø h	MRP
LOD 44512	12	3000K/4000K/6000K	16°/24°/36°	118		

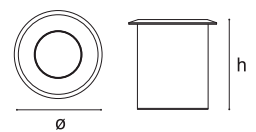

Available Colors ●

Elava



IP 67 in ground LED luminaire die cast housing stainless steel cover, anti-corrosion resistant, tempered clear glass with optical lens & Integrated driver.

Product ID	Watt	CCT	Beam Angles	Cutout (mm) ø	Dimension (mm) ø h	MRP
LOD 44515	15	3000K/4000K/6000K	16°/24°/36°	148.5		
LOD 44518	18	3000K/4000K/6000K	16°/24°/36°	148.5		

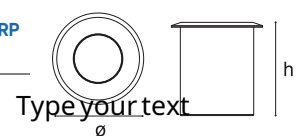

Available Colors ●

Type your text

Mushroom



IP65

IP 65 LED bollard is suitable for landscape stabilized lighting applications. Luminaire is made of high grade corrosion resistant powder coated aluminium body with UV stabilized vandal proof PC diffuser.

Product ID	Watt	CCT	Dimension (mm) ø h	MRP
LBM 7009	9	3000K/6000K	150 600	

Available Colors ●

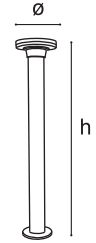

Fern



IP65

IP 65 LED bollard is suitable for landscape stabilized lighting applications. Luminaire is made of high grade corrosion resistant powder coated aluminium body with UV stabilized vandal proof PC diffuser.

Product ID	Watt	CCT	Dimension (mm) ø h	MRP
LBF 7010	10	3000K/6000K	122 600	

Available Colors ●

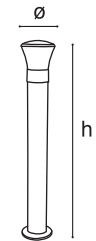

Torch



IP65

IP 65 LED bollard is suitable for landscape stabilized lighting applications. Luminaire is made of high grade corrosion resistant powder coated aluminium body with UV stabilized vandal proof PC diffuser.

Product ID	Watt	CCT	Dimension (mm) ø h	MRP
LBT 7010	10	3000K/6000K	175 600	

Available Colors ●

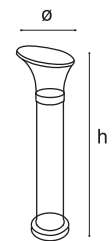

Ring Mini



IP65

Post top fixture for pole mounted application. Aluminium housing with corrosion resistant powder coat and UV stabilised vandal proof milky diffuser. IP65 protection suitable for outdoor application.

Product ID	Watt	CCT	Pole Dia (Inner) (mm) ø	Dimension (mm) ø h	MRP
LPT 4530	30	3000K/4000K/6000K	58.5	407 210	

Available Colors ●

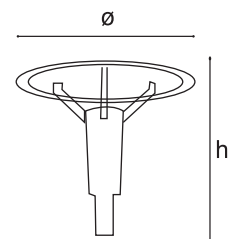

Ring



Post top fixture for pole mounted application. Aluminium housing with corrosion resistant powder coat and UV stabilised vandal proof milky diffuser. IP65 protection suitable for outdoor application.

Product ID	Watt	CCT	Pole Dia (Inner) (mm) ø	Dimension (mm) ø h	MRP
LPT 6560	60	3000K/4000K/6000K	77.5	575 370	

Available Colors ●

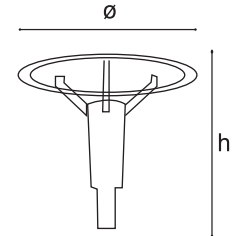

Marshall



Post top fixture for pole mounted application. Aluminium housing with corrosion resistant powder coat and UV stabilised vandal proof milky. IP65 protection suitable for outdoor application.

Product ID	Watt	CCT	Pole Dia (Inner) (mm) ø	Dimension (mm) ø h	MRP
LPM 4525	25	3000K/4000K/6000K	66	350 470	
LPM 4530	30	3000K/4000K/6000K	66	350 470	

Available Colors ●

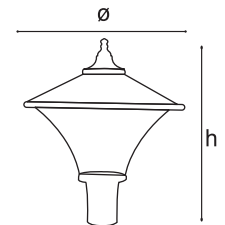

Marshall



Post top fixture for pole mounted application. Aluminium housing with corrosion resistant powder coat and UV stabilised vandal proof milky. IP65 protection suitable for outdoor application.

Product ID	Watt	CCT	Pole Dia (Inner) (mm) ø	Dimension (mm) ø h	MRP
LPM 4545	45	3000K/4000K/6000K	76.5	450 520	

Available Colors ●

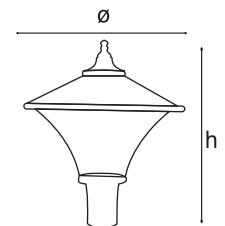

Bruno



Post top fixture for pole mounted application. Aluminium housing with corrosion resistant powder coat and UV stabilised vandal proof clear diffuser. IP65 protection suitable for outdoor application.

Product ID	Watt	CCT	Pole Dia (Inner) (mm) ø	Dimension (mm) ø h	MRP
LPB 1030	30	3000K/4000K/6000K	76	370 450	

Available Colors ●

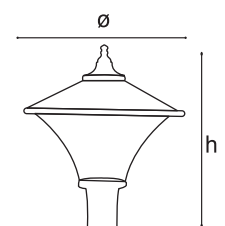

Bruno 2



Post top fixture for pole mounted application. Aluminium housing with corrosion resistant powder coat and UV stabilized vandal proof clear diffuser. IP65 protection suitable for outdoor application.

Product ID	Watt	CCT	Pole Dia (Inner) (mm) \varnothing	Dimension (mm) \varnothing h	MRP
LPB 1125	25	3000K/4000K/6000K	66	350 470	
LPB 1130	30	3000K/4000K/6000K	66	350 470	

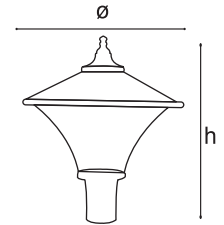

Available Colors ●

Ogee



Post top fixture for pole mounted application. Aluminium housing with corrosion resistant powder coat and UV Stabilized Injection moulded Poly Carbonate with Prismatic Cut. IP66 protection suitable for outdoor application.

Product ID	Watt	CCT	Pole Dia (Inner) (mm) \varnothing	Dimension (mm) \varnothing h	MRP
LPO 3525	25	3000K/4000K/6000K	70	332 473	

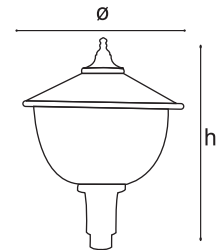

Available Colors ●

Bolt



IP 65 Lamp Post is suitable for outdoor lighting applications. Luminaire is made in spin aluminium housing with corrosion resistant powder coated and UV stabilized vandal proof clear PC diffuser.

Product ID	Watt	CCT	Pole Dia (Inner) (mm) \varnothing	Dimension (mm) \varnothing h	MRP
LPB 4045	45	3000K/4000K/6000K	69	450 680	

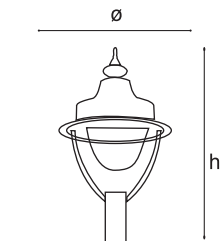

Available Colors ●

Titan



IP 65 Lamp Post is suitable for outdoor lighting applications. Luminaire is made in die-cast aluminium housing with corrosion resistant powder coated and UV stabilized vandal proof PC diffuser.

Product ID	Watt	CCT	Pole Dia (Inner) (mm) \varnothing	Dimension (mm) b h	MRP
LPT 3045	45	3000K/4000K/6000K	78		

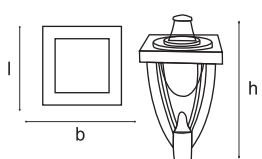

Available Colors ●

Hornet



IP 65 Lamp Post is suitable for outdoor lighting applications. Luminaire is made in spin aluminium housing with corrosion resistant powder coated and UV stabilized vandal proof clear PC diffuser.

Product ID	Watt	CCT	Dimension (mm) ø h	MRP
LHT 1050	50	3000K/4000K/5700K	625 630	
LHT 1090	90	3000K/4000K/5700K	625 630	

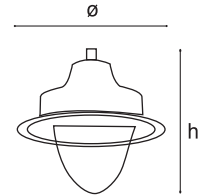

Available Colors ●



Municiple Corporation, Chandigarh



Ahmedabad, University



Matshya Narayan, Nepal



IGI Airport-T3 to T2, Delhi



PCMC, Pune



Gov. Street Lighting, W.B.

D Lite



The decorative luminaire suitable for LED bulbs available in different color options. Designer product suitable for various interior intent size option offers flexibility with respect to product application. Neat design with minimalistic approach.

Product ID	Watt	CCT	Dimension (mm) ø h	MRP
LDTE 300	9/12/15	3000K/4000K/6000K	305 185	
LDTE 380	9/12/15	3000K/4000K/6000K	373 205	
LDTE 425	9/12/15	3000K/4000K/6000K	425 210	
LDTE 600	9/12/15	3000K/4000K/6000K	600 320	

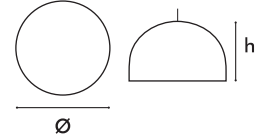

Available Colors Other colors as per request

Zeta



The decorative luminaire suitable for LED bulbs available in different color options. Inspired by water droplet, fixture has fluid design intent. Softness in design makes it suitable for almost any interior fit out.

Product ID	Watt	CCT	Dimension (mm) ø h	MRP
LZTE 3030	9/12/15	3000K/4000K/6000K	257 210	
LZTE 3020	9/12/15	3000K/4000K/6000K	368 280	
LZTE 3010	9/12/15	3000K/4000K/6000K	420 280	

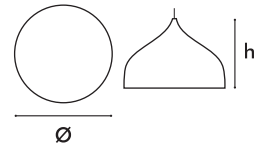

Available Colors Other colors as per request

Type your text

Mole



The decorative luminaire suitable for LED bulbs available in different color options. Compact and cute design which can be used in a cluster. Simple and yet elegant, Mole can be used on various breakout areas of both residential and commercial fit outs.

Product ID	Watt	CCT	Dimension (mm) ø h	MRP
LMOL 205	9/12/15	3000K/4000K/6000K	205 175	

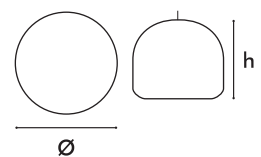

Available Colors Other colors as per request

Tope



The decorative luminaire suitable for LED bulbs available in different color options. Tope with industrial touch and robust feel is inspired from grunge design.

Product ID	Watt	CCT	Dimension (mm) ø h	MRP
LTOP 405	9/12/15	3000K/4000K/6000K	405 265	

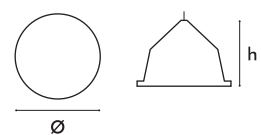

Available Colors Other colors as per request



Private

DELHI INTERNATIONAL AIRPORT TERMINAL-3	STRYKER	TASKUS	HONDA	HUL			
COOPER	PRAVIN MASALA	THYSSENKRUPP	INDIANA GRATINGS	PIAGGIO			
ARISTOCRAT	DELOITTE	HAWAS MEDIA	WILEY	PWC	IBBIBO	SCHNEIDER	
AMAZON	ZOMATO	FREECHARGE	COCA-COLA	AIRBNB	RENEW POWER		
MAKEMYTRIP	REGUS	IIFL	PIRAMAL	PVR	ERICSSON	QUICKHEAL	
CANON	ADANI	VML	PAYTM	SODEXO	9A BUSINESS	HAWORTH	HP
BAE	AUTODESK	TCS	PEARL ACADEMY	SAMSUNG	TATA MOTORS		
ADITYA BIRLA	TATA SKY	SOMANY	KALPATARU	ACCENTURE			
WESTERN UNION	LEGATO	SABA SOFTWARE	E-ZEST	COX & KINGS			
MAX	ATHENA	GLG	WINDSOR IT PARK	ERICSSON	ITTPL		
MANIPAL HOSPITAL	GROHE	DELHI GYMKHANA	EON IT PARK KHARADI				
AZURE	SAS	TIBCO	DECCAN GYMKHANA	EDIFECS	BIRLASOFT		
LG CHEM	MARKIT	CLEO COUNTY	VALUE PLUS	SIRION LAB			
MOTT & MACDONALD	GODREJ	JAISPRING	IZENICA	DALMIA			
CLAIRVOLEX	AIRTEL	CUX CAPITAL	APCER	CLIFFORD	CINEPOLIS		
APOLLO TYRES	BAJAJ CAPITALS	BROWER STACK	CORNING				
UPES BIDHOLI	SONY	KAS	INDIABULLS	CSGI	LOHIA GROUP	BAJAJ	
FREECHARGE	RAYMOND	BKT	PEARSON	DIVERSE LYNX			
JAIPURIA SCHOOL	VARSA PLASTIC IOC	HYUNDAI MOTOR	YES BANK				
GOOGLE	SHAHI EXPORT	RADHANIK EXPORT	YES BANK	BANK OF BAHRAIN			
BANDHAN BANK	MARRIOT HOTEL	AMBUJA, KOLKATA					

Government

| DELHI INTERNATIONAL AIRPORT TERMINAL-3 | KATHMANDU AIRPORT - NEPAL |
| M.C. CHANDIGARH | EMBASSY OF SAUDI ARABIA, POLAND, BULGARIA, FINLAND,
THE REPUBLIC OF KOREA, THE REPUBLIC OF POLAND |
AMBASSADOR'S RESIDENCE OF POLAND	BIR HOSPITAL - NEPAL		
PUNJAB MANDI BOARD BHARAT PETROLUM	GOVERNMENT COLLEGE HARYANA		
INDIAN RAILWAY	RAPID METRO	HARYANA HIGH COURT	PHOOL BAGH
PUNJAB HOUSING BOARD	CIRCUIT HOUSE		
RAJIV INSTITUTE & RESEARCH CENTRE	SIR GANGA RAM HOSPITAL		
SHATABDI SPER	SPECIALITY HOSPITAL		
UTTAR PRADESH RAJKIYA NIRMAN NIGAM LTD.	PWD HARYANA		
KANPUR	DEVELOPMENT AUTHORITY	TAJ CORRIDOR	MINI SECRETARIAT
MUNICIPAL CORPORATION CHANDIGARH , BORDER SECURITY FORCE (BSF)			
DEPARTMENT OF AGRICULTURE COOPERATION AND FARMERS WELFARE -			
(NORTHERN FARM MACHINERY TRAINING & TESTING INSTITUTE HISSAR)			
ARMY HEADQUARTERS - NEPAL			



Terms & Conditions

- 1- All prices stated in the price list are in Indian Rupees (INR)
- 2- Prices are subject to change without any notice.
- 3- All products may vary from the photographs shown in this price list. Although every effort has been made to ensure accuracy in the compilation of the technical details in this publication.
- 4- Due to continual development and improvement process, product specs may change any time without prior notice.

Legero
LED Lighting



Legero Lighting

Corporate Office

E-139, Sector 63, Noida - 201301, India
+91 120 4272775
info@legerolighting.com

Pune Office

Gate No. 1338/1, Priyanka Nagari,
Nagar-Pune Road, Jadhav Wasti,
Wagholi, Pune - 412207

legerolighting.com